

Click-Ductor®

Insulated conductor bar for
current capacities up to 400A

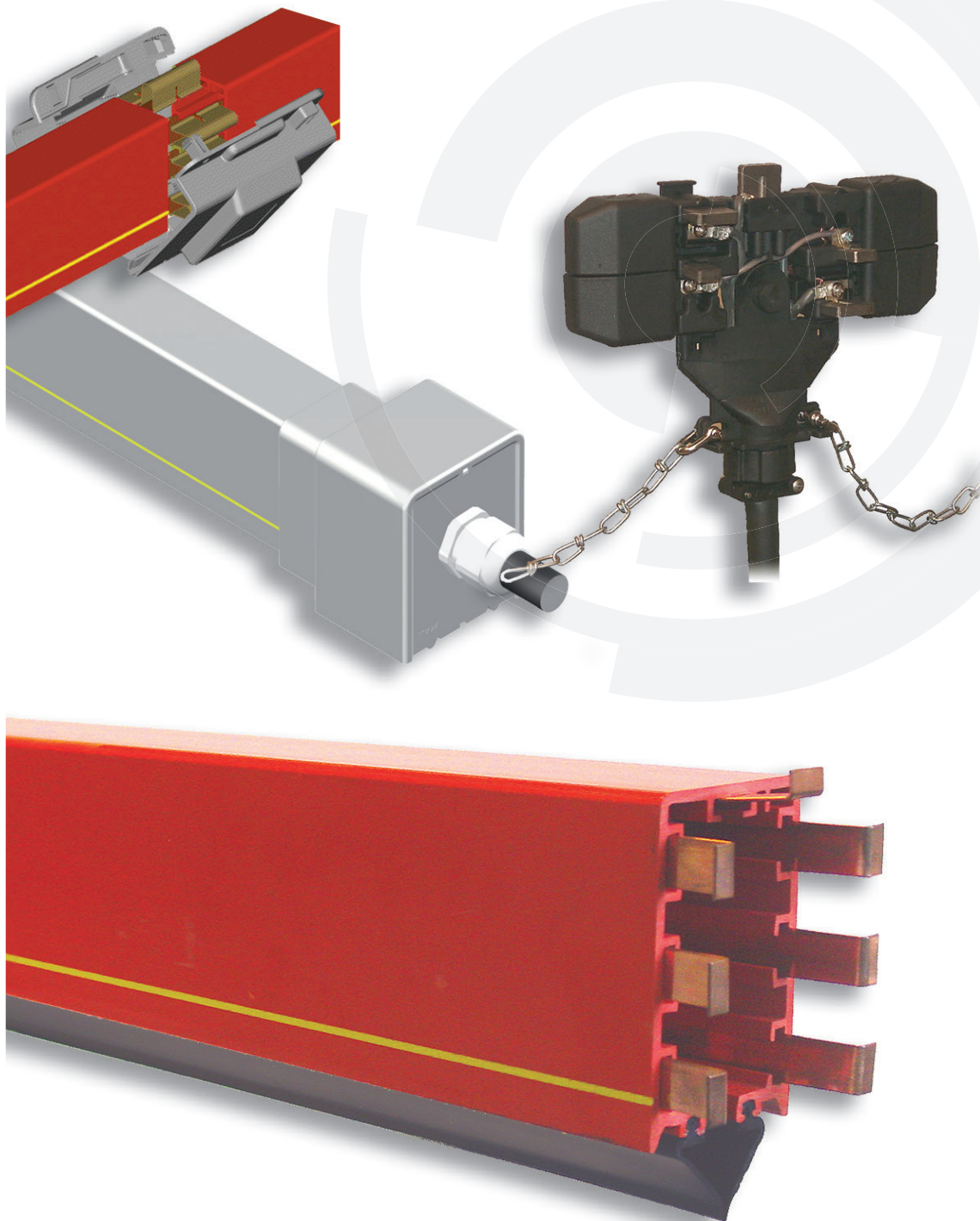

AKAPP Click-Ductor®

- The reliable conductor system for cranes, hoists, conveyors and many other applications
- Current capacities: 50, 80, 110, 125, 160, 200, 320 and 400A
- Conductor housing available with 4, 5 or 7 conductors
- Adjustable to almost all heights
- Flexible sealing against dust, moisture and humidity
- Long tracks possible
- Easy and fast mounting
- Virtually maintenance free



AKAPP Click-Ductor system has a unique concept. Based on free expansion of housing and conductors. The pre-mounted conductors are connected with convenient copper clips with clamp or screwed tightening.

The conductor housings can be connected by means of self clamping joints, without using any tools!

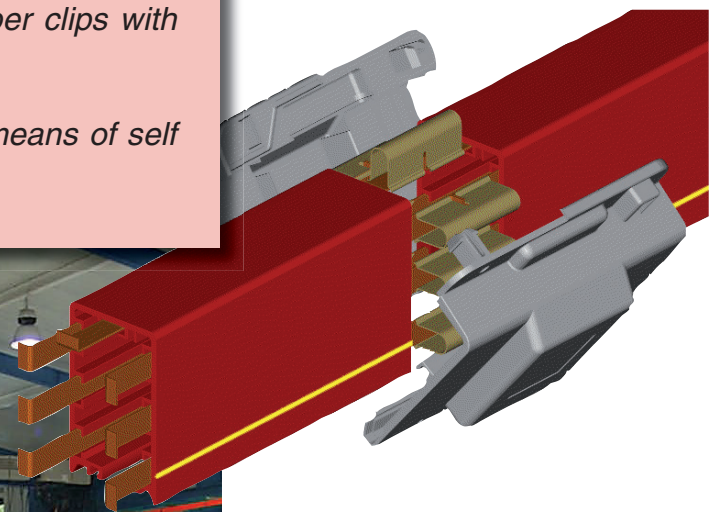

AKAPP Click-Ductor® conductor system: combination of flexibility and efficiency!

Compact, reliable and safe power supply fitted with an easy click-system, for e.g. cranes and hoisting equipment.

The unique construction combines flexibility and efficiency. Click-Ductor can be used for both indoor and outdoor applications.

This brochure provides a brief summary of the extensive possibilities of the system.

For further information we refer to our web site: www.akapp.com.

We refer to the front cover of this brochure for detailed information on our address.

Some important features:

Optimum reliability is assured by the advantages listed below.

Quick and easy installation, based on the well-designed click-system by which the conductors are mutually connected and the joint clamps without screw connection.

Up to 7 copper channels. The copper channels offer sufficient room for 4, 5 or 7 conductors, as required. The 7-pole performance offers parallel mounting of the conductors for higher current capacities.

6 types of conductors. The flat copper conductors, suitable for current capacities up to 50A, 80A, 110A, 125A, 160A and 200A.

High current capacity. Standard up to 400A with parallel-mounted conductors.

Easy-to-connect conductors. The flat copper conductors, which have been provided within the synthetic housing, can be connected quickly and easily by means of a simple, patented, click-system. Unique! For current capacities higher than 110A the conductors will be connected by means of screw connectors.

Joint clamps without screw connection. The joint clamps are clicked on effortlessly, whilst no tools are used!

Easy to be removed rail sections. Due to the fact that the outer ends of the copper conductors are positioned against one another, the housing can easily be removed whilst the other housings do not need to be moved.

Yellow uninterrupted earth marking. Clearly indicates the earth conductor. Safety!

Compact construction. The housing is 51.4 mm wide and the height is 86.25 mm. It is therefore nearly always suitable for all situations.

Long track lengths possible. Track lengths up to 800 m (including central feeding) can be obtained. This is applicable for outdoor installations as well.

Dust, moisture and humidity protection. For these conditions the Click-Ductor housing RC7 can be totally closed by the use of special flexible sealing strips.

Anti reverse rib. Prevents improper installation of the collector trolley into the conductor housing.

Contact safe. Due to the high insulation value of the synthetic material, the operational safety has significantly improved. Moreover, the conductor RC7 has a conspicuous red colour, which improves safety as well.

Self-extinguishing. For safety reasons the housing materials are self-extinguishing.

Degree of protection IP 44. AKAPP Click-Ductor with flexible sealing strips meets degree of protection IP 44. Without sealing strips the degree of protection is IP23.

AKAPP Click-Ductor offers easy and quick mounting, low maintenance, is contact safe and has a very attractive price/quality relationship!

Click-Ductor® housings RC4 and RC7:

complete segments, connection accomplished in seconds!

In the PVC housing RC4 4 copper conductors are provided. The PVC housing RC7 has 7 channels in which 4, 5 or 7 conductors, upon demand, are positioned. The capacity depends on the requirement.

The availability of the housing is either 3 or 4 metres. Connection of the housings is established by means of joint clamps. Clamps connect the conductors. No screws are needed; installation is effected by means of simply clicking!

An anti-reverse rib (A) on top of the housing prevents cross phasing, incorrect placement of a collector trolley in the conductor system. A continuous yellow marking (B) on one side of the housing simplifies correct mounting of the system. The PVC-housing is self-extinguishing.

The housing RC7 can be provided with flexible rubber strips. As such penetration of dust and moisture can be minimised as a result of which an optimum of reliability is ensured!

Type RC4

with 4 copper conductors.

Color housing: grey.

Temperature range: -20 °C up to +50 °C.

Suitable for indoor applications.

Type RC7-4

with 4 copper conductors. Housing suitable for AS7 sealing strips (see picture right).

Color housing: signal red.

Temperature range: -20 °C up to +50 °C.

Suitable for indoor and outdoor applications.

Type RC7-5

Housing equal to RC7-4, however with 5 copper conductors. Temperature range: -20 °C up to +50 °C. Suitable for indoor and outdoor applications.

Only available on special request.

Type RC7-7

Housing equal to RC7-4, however with 7 copper conductors. Temperature range: -20 °C up to +50 °C. Suitable for indoor and outdoor applications.

All Click-Ductor rail types are available in lengths of 3 metres and 4 metres. For a complete overview of all available rail types including copper conductors, please see the table on page 5.

Flexible sealing strips AS7 (art.no. 1004030)

Type AS7 C chloroprene, color black

This is used to ensure the suitability of a Click-Ductor RC7 installation for application in a **dusty** or **humid** atmosphere. It is also a very effective protection against corrosion of the copper conductors! This sealing is recommended for all outdoor installations.

Rail type RC7 **with AS7** meets protection degree **IP44** and is permitted to be mounted on every desired height.

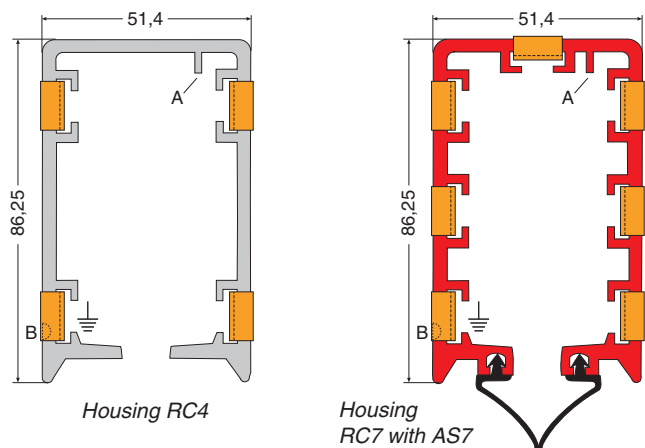

Technical data of housings

Material

Unplasticized Hard-PVC with approximate values:

Notch shock strength	5-10 kJ/m ²
E-modulus	2500-3000 N/mm ²
Softening point (Vicat)	81-83°C
Linear expansion	70.10 ⁻⁶ m/m/°C

Elektrical data

Volume resistivity with 100 V	>4.10 ¹⁵ Ω/cm
Dielectric strength with 50 Hz	>30 kV/mm
Flame class UL94	V0

Length of housing 3 m and 4 m

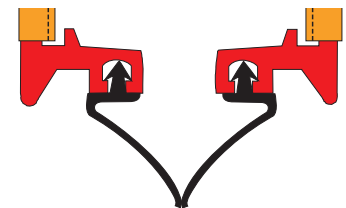

Conductors in the housings

The conductors have been positioned into the housings as illustrated on the right-hand side.

Indication of a conductor housing including copper strips is e.g. **RC7-7-50**.

RC7 = type of housing

7 = number of conductors

50 = capacity of the conductors

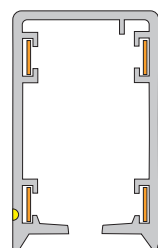

Housing RC4, standard 4-poles

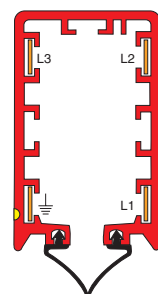

Housing RC7, standard 4-poles

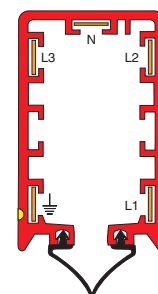

Housing RC7, 5-poles (available only on request)

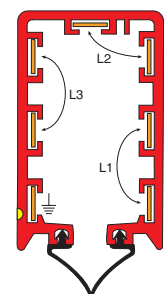

Housing RC7, standard 7-poles, parallel conductors

Click-Ductor® railtypen RC4 and RC7: overview of available types

This page shows an overview of all available types Click-Ductor RC4 and RC7.

Alle types are deliverable in both 3 metre and 4 metre sections. Combining these lengths makes practically every system length possible.

Housing types RC7 can be fitted with double sided chloro-prene sealing strips AS7 (see also page 4). These strips need to be ordered separately.

The maximum current capacity per rail type, presented in the table below, is valid with duty cycle (D.C.) of 80%, however the current capacity for 200A conductor systems is valid with 60% D.C..

If you need more information about the possibilities of Click-Ductor housings, please contact our sales department.

AKAPP NO.	DESCRIPTION	Imax 80% D.C. (A)	max 80% D.C. (A) Parallel Cu	max. track length (m) **)
Rail type RC4 Length 3 metres				
2101065.B0000	Rail section grey RC4-4-50/3M, 4 poles, 50 A	50		200
2101265.B0000	Rail section grey RC4-4-80/3M, 4 poles, 80 A	80		360
2110490	Rail section grey RC4-4-110/3M, 4 poles, 110A	110		500
2110500	Rail section grey RC4-4-125/3M, 4 poles, 125A	125		800
2110510	Rail section grey RC4-3-160/1-125/3M, 4 poles, 160A	160		800
2110520	Rail section grey RC4-3-200/1-125/3M, 4 poles, 200A	200 *)		800
Rail type RC4 Length 4 metres				
2101075.B0000	Rail section grey RC4-4-50/4M, 4 poles, 50 A	50		200
2101275.B0000	Rail section grey RC4-4-80/4M, 4 poles, 80 A	80		360
2110370	Rail section grey RC4-4-110/4M, 4 poles, 110A	110		500
2110380	Rail section grey RC4-4-125/4M, 4 poles, 125A,	125		800
2110390	Rail section grey RC4-3-160/1-125/4M, 4 poles, 160A	160		800
2110400	Rail section grey RC4-3-200/1-125/4M, 4 poles, 200A	200 *)		800
Rail type RC7 Length 3 metres				
2103065.B0000	Rail section red RC7-4-50/3M, 4 poles, 50 A	50		200
2103365.B0000	Rail section red RC7-4-80/3M, 4 poles, 80 A	80		360
2110530	Rail section red RC7-4-110/3M, 4 poles, 110A	110		500
2110540	Rail section red RC7-4-125/3M, 4 poles, 125A	125		800
2110550	Rail section red RC7-3-160/1-125/3M, 4 poles, 160A	160		800
2110560	Rail section red RC7-3-200/1-125/3M, 4 poles, 200A	200 *)		800
2103155.B0000	Rail section red RC7-7-50/3M, 7 poles, 50 A	50		200
2103455.B0000	Rail section red RC7-7-80/3M, 7 poles, 80 A	80		360
2110570	Rail section red RC7-7-110/3M, 7 poles, 110A	110	220	500
2110580	Rail section red RC7-7-125/3M, 7 poles, 125A	125	250	800
2110590	Rail section red RC7-7-160/3M, 7 poles, 160A	160	320	800
2110600	Rail section red RC7-7-200/3M, 7 poles, 200A	200 *)	400 *)	800
Rail type RC7 Length 4 metres				
2103075.B0000	Rail section red RC7-4-50/4M, 4 poles, 50 A	50		200
2103375.B0000	Rail section red RC7-4-80/4M, 4 poles, 80 A	80		360
2110410	Rail section red RC7-4-110/4M, 4 poles, 110A	110		500
2110420	Rail section red RC7-4-125/4M, 4 poles, 125A	125		800
2110430	Rail section red RC7-3-160/1-125/4M, 4 poles, 160A	160		800
2110440	Rail section red RC7-3-200/1-125/4M, 4 poles, 200A	200 *)		800
2103165.B0000	Rail section red RC7-7-50/4M, 7 poles, 50 A	50		200
2103465.B0000	Rail section red RC7-7-80/4M, 7 poles, 80 A	80		360
2110450	Rail section red RC7-7-110/4M, 7 poles, 110A	110	220	500
2110460	Rail section red RC7-7-125/4M, 7 poles, 125A	125	250	800
2110470	Rail section red RC7-7-160/4M, 7 poles, 160A	160	320	800
2110480	Rail section red RC7-7-200/4M, 7 poles, 200A	200 *)	400 *)	800

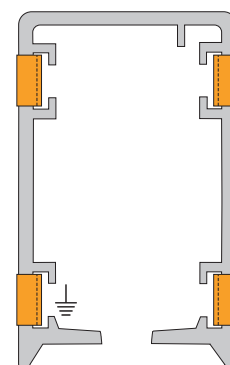

Click-Ductor
type RC4-4..

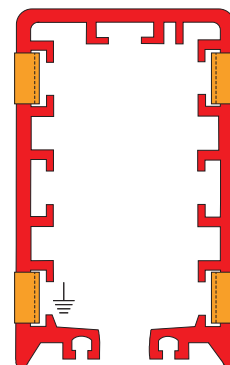

Click-Ductor
type RC7-4..

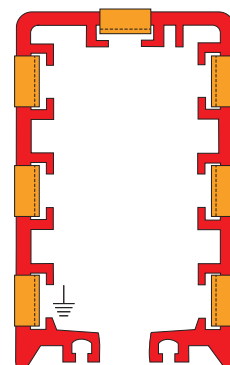

Click-Ductor
type RC7-7..

*) 60% D.C.

**) Lengths valid for systems with centre feed (fixed point in the middle);
for systems with end feed these lengths should be divided by 2.

Rail type RC7-5 on request

Hanging and fixing of the housing: free expansion at all times!

The principle of the AKAPP conductor bar systems with clicked or screwed conductors is based on the free expansion of the pvc housing and the internal conductors. The conductor housing is therefore suspended in sliding hangers in which these conductors - upon the occurrence of differences of expansion - can slide continuously and who are fixed at the feed point only by means of a **fixed point clamp** at the construction. Sliding hangers and fixed point clamps are available in 2 types, for maximal adaption to the environmental conditions. See adjacent frame.

Finishing of metal sliding hangers and joints

Type Z - Galvanised, for **normal indoor installations**.

Type L - Galvanised + epoxy coated, for **indoor and outdoor installations**.

Sliding hanger

Type BN7-Z and Type BN7-L

The sliding hangers are fastened to the suspension frame by means of a bolt. As such the installation can be **aligned vertically**.

Centre distance of hanger supports:

1355 mm : all copper capacities; indoor and outdoor installations

2032 mm : all copper capacities; indoor installations only.

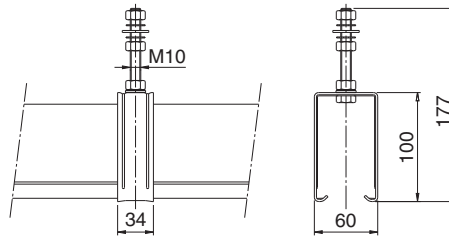

BN7-L

Fixed point clamp

Type VMN7-Z and Type VMN7-L

The complete conductor installation is to be fastened to the suspension frame by means of a self-gripping fixed point clamp. As of this location, the conductor housing can slide freely in the sliding hangers when expansion differences, due to temperature variation, occurs.

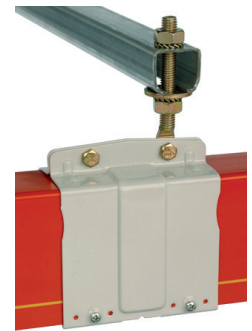
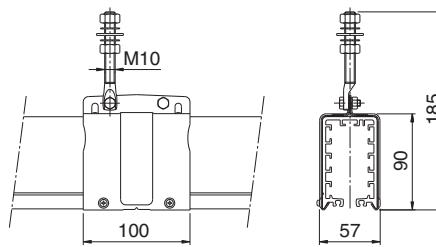

VMN7-L

Support bracket

Type UH330 : l=330 mm, galvanised

Type UH500/(R) : l=500 mm, galvanised

Type UH700/(R) : l=700 mm, galvanised

Special length on request. These brackets have clamps attached to sliding nut assemblies thus facilitating a flexible mounting arrangement capable of accomodating various sizes of RSJ (INP) beams, allowing simple **horizontal alignment**.

Note: For fast mounting on site, **pre-mounted** support brackets with sliding hanger are available on request! See page 13 for more info.

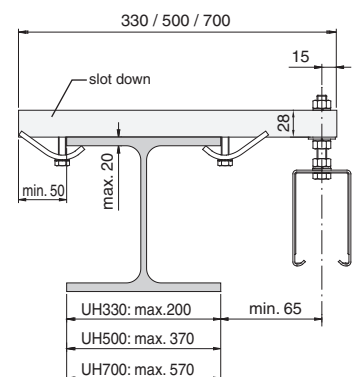
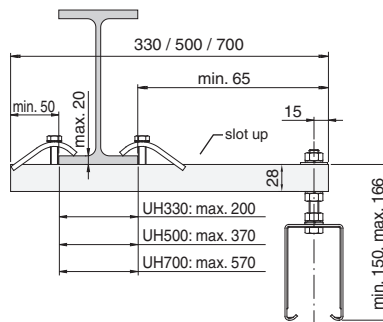

AKAPP NO.	DESCRIPTION	ambient is	
		dry	humid
1004570	Sliding hanger galvanised BN7-Z	x	
1004650	Sliding hanger epoxy coated BN7-L		x
1004960	Fixed point clamp galvanised VMN7-Z	x	
1005070	Fixed point clamp galv.+epox. VMN7-L		x

AKAPP NO.	DESCRIPTION	length (mm)
1018010	Support bracket galv. 330mm UH330	330
1018160	Support bracket galv. 500mm UH500	500
1018320	Support bracket galv. 700mm UH700	700

Click-Ductor® copper connections: quick and sure by clicking or screwing

The opposite segments of the copper conductors within each housing of a Click-Ductor system are connected to each other in a fast, simple and effective way.

Copper connectors are available with click or screwed fastening. Which type is applied, depends on the maximum current of the apparatus to be fed.

Copper connectors with click fastening is applicable for copper conductors 50A, 80A and 110A. For higher current capacities copper connectors with screwed fastening should be used.

The copper connections are covered by means of a joint clamp, consisting of 2 halves with a simple click fastening.

Connectors

1. Copper connectors with click fastening:

Type Cu-C: For joining copper conductors 50A and 80A. The resilient brass clamps automatically click on the outer ends of the strips. A recess as provided within the clamp ensures that the strips will continuously be held together. The required number of connectors is to be ordered separately.

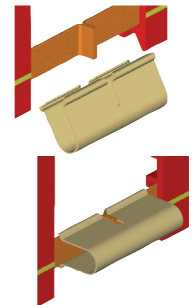
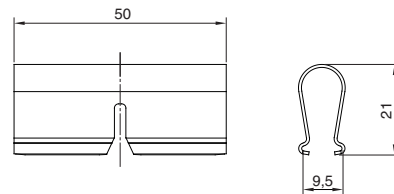

Mounting the connector Cu-C

2. Copper connectors with click fastening:

Type Cu-CL: For joining copper conductors 110A. These clamps are similar to the type Cu-C, however suitable for current capacities up to 110A (80% ID). On both sides a marking is provided (see drawing).

The required number of connectors needs to be ordered separately.

For current capacities above 110A copper connectors with screw fastening are used (see below).

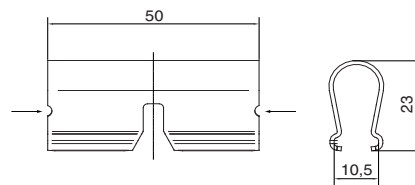

3. Copper connectors with screw fastening:

Type Cu-S: For joining copper conductors 125A, 160A and 200A. The copper conductors are connected to each other by means of a solid screw fastening. Fastening the nuts results in a very dependable and sure connection.

These systems with copper conductors 125A, 160A and 200A have **pre-mounted** clamps, that do not have to be ordered separately.

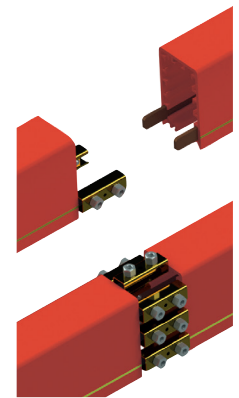
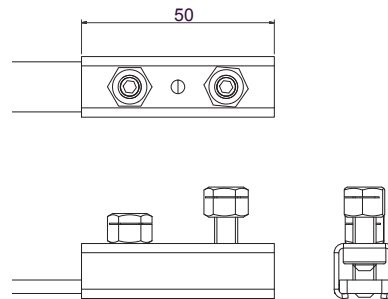

Mounting the connector Cu-S

Joint clamp

Type VC: plastic

The joint clamp consists of 2 half parts which can easily be mutually connected by means of a click-connection.

The joint clamps have two recesses, which are provided at the inner side, in order to fasten the clamps and conductor housings. Available in protection degree IP23 and IP44.

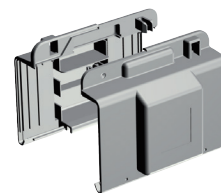

Joint clamp VC separate halves

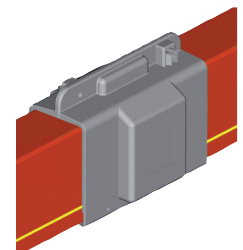

Joint clamp VC mounted

AKAPP NO.	DESCRIPTION
2105450	Copper connection clamp for RC4/7 Cu-C
2105460	Copper connection clamp large for RC4/7 CU-CL
2105060	Screw connector CU-S complete
2105400	Joint clamp VC
2105420	Joint clamp VC-IP44

End feed boxes

efficient and reliable solutions

End feed boxes are used for the connection of the feeder cable to the extreme end of the Click-Ductor system (see picture).

All feed boxes are fitted with metric glands. It is possible to use extra glands and/or several diameter ranges from type EB40.

End feed clamps are required for connection of copper conductors 125A or 160A (see details below).

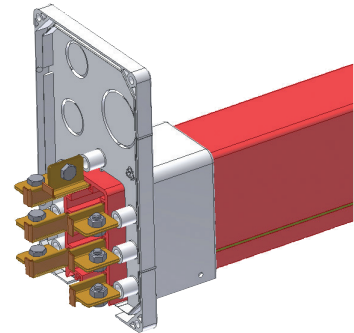

EB40 (opened)

End feed boxes

Type EBS32

Compact end feed box with cable gland M32, suitable for cables Ø10-Ø21 mm. Connecting screws M6 included.

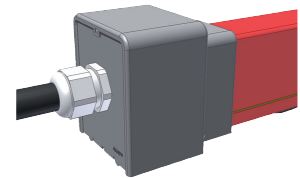
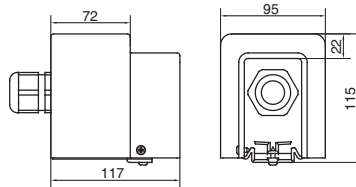

EBS32

Type EB40

End feed box for with cable gland M40, suitable for cables Ø16-Ø28 mm. The push-through holes offer easy mounting of various cable glands. Connecting screws M6 included.

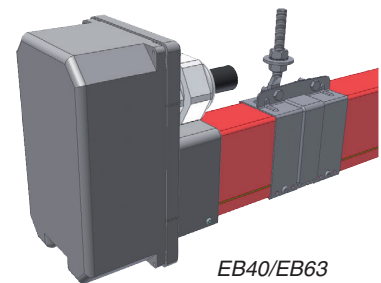
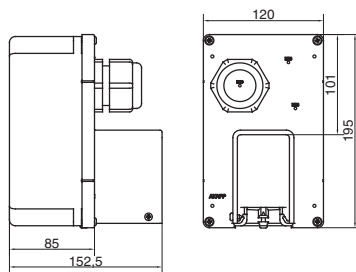

EB40/EB63

Type EB63

As end feed box EB40, with cable gland M63, suitable for cables Ø30-Ø44,5 mm.

End feed clamps

Type RC-EC80

Required for connecting copper conductors Cu50A or Cu80 to the end feed box. To be ordered separately.



RC-EC80

Type RC-EC110

Required for connecting copper conductors Cu110 to the end feed box. To be ordered separately.

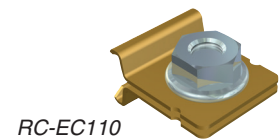
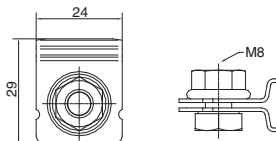

RC-EC110

Type LC200

Required for connecting copper conductors 125A, 160A or 200A to the end feed box (**max. 4 conductors**). To be ordered separately.

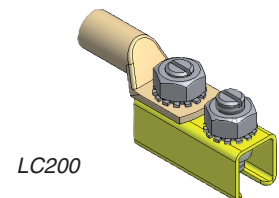
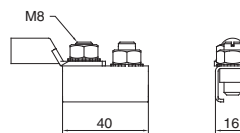

LC200

AKAPP NO.	DESCRIPTION	outer diameter feeder cable Ø (mm)	max. occupation copper conductors	l _{max} (80% DC) non-parallel (A)	IP-class excl. AS7 sealing strip	IP-class incl. AS7 sealing strip
1006830	End feed box EBS32 1xM32	10-21	4xCU80 / 7xCU50	80	IP23	IP44
1006800	End feed box EB40 1xM40	16-28	4xCU125 / 7xCU80	125	IP23	IP44
1006810	End feed box EB63 1xM63	30-44	4xCU160 / 7xCU80	160	IP23	IP44
1006820	End feed box EB	no glands			IP23	IP44
2109000	End feed clamp RC-EC80			80		
2109005	End feed clamp RC-EC110			110		
1013000	Feed clamp LC200			200		

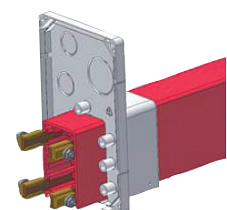

Line feed boxes: designed for more flexibility

Lines feed boxes are used for the connection of the feeder cable on any random point of the system. The feeder cable, connected to line feed clamps, is kept in place by the line clamp holder that partly slides over the 2 housing parts in which up to 7 line feed clamps can be fitted.

Basis of all the line feed boxes is the modular collar that is equipped with push through holes to fit various glands M32 to M63 in size. For custom configurations, you can easily add glands by removing the pre-cut sections.

The line feed clamp holder (LCH) connects 2 adjacent rail housings and holds the line feed clamps at the same time.

Then the line feed clamps are connected to a power cable. Cover comes over the collars and clicks into position.

Line feed boxes types LB

Type LB40

Line feed box for connection of copper conductors up to 125A. With 1 gland M40 for cables Ø16-Ø28 mm.

Type LB63

Line feed box for connection of copper conductors up to 160A. With 1 gland M63 for cables Ø30-Ø44,5 mm.

Type LB32-4

Similar to LB63, with 4 glands M32 for cables Ø10-Ø21 mm.

Type LB32-7

Similar to LB32-4, with 7 glands M32 for cables Ø10-Ø21 mm.

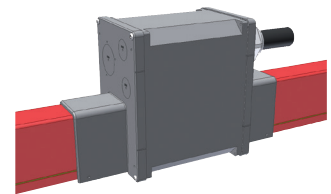
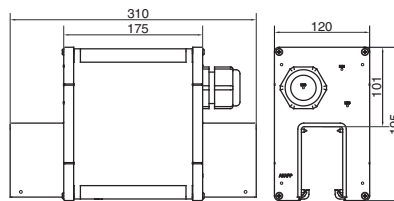

LB40/LB63

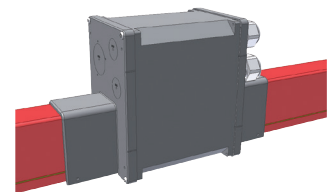
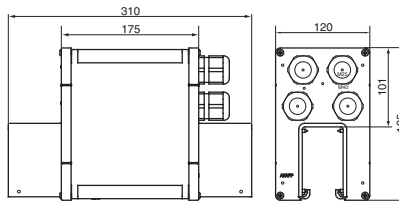

LB32-4

Line feed clamp holders

Type RC-LCH

Applicable for line feed connections with continuous copper (all sizes), irrespective the number of poles. When mounting, the line feed clamp holder (2 halves) clamps over 2 adjacent rail housings with the line feed clamps already fitted to the copper conductors. See figure.

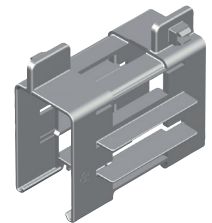
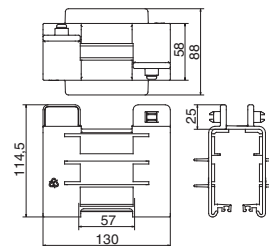

RC-LCH

The required line feed clamps have to be ordered separately.

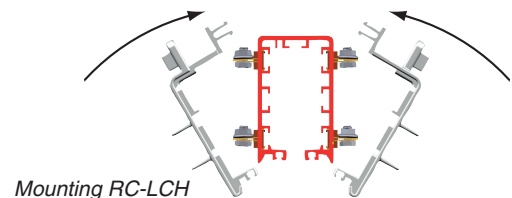

Mounting RC-LCH

AKAPP NO.	DESCRIPTION	outer diameter feeding cable Ø (mm)	max. number of copper conductors	I _{max} (80% DC) non-parallel (A)	I _{max} (80% DC) parallel switched (A)	IP-class excl. AS7 sealing	IP-class incl. AS7 sealing
1006900	Line feed box LB40 1xM40	16-28	4xCU125 / 7xCU80	125	-	IP23	IP44
1006910	Line feed box LB63 1x M63	30-44	4xCU160 / 7xCU125	160	250	IP23	IP44
1006920	Line feed box LB32-4 4xM32	4x 10-21	4xCU160	160	-	IP23	IP44
1006930	Line feed box LB32-7 7xM32	7x 10-21	7xCU200	173	346	IP23	IP44
1006940	Line feed box LB	no glands				IP23	IP44
2109050	Line feed clamp holder RC-LCH					IP23	IP44

Connecting the copper conductors: skillful solutions with clamps and boxes

All line feed systems require clamp holders and feed clamps to connect the copper conductors within the rail housing to the cores of the supply cable (see also page 9).

There are 3 types of feed clamps: RC-LC80, RC-LC110 and RC-LC200.

To connect the copper conductors to a cable terminal in a transition box, the transition cables OK25, OK35 or OK50 can be used. In some cases, it can replace a feeder cable with a too large outer diameter.

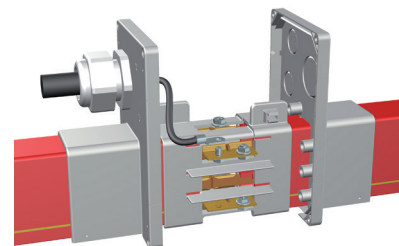

RC-LCH + RC-LC80

Feed clamps

Type RC-LC80

To be applied for mounting copper conductors Cu50 - Cu80. Click connection.

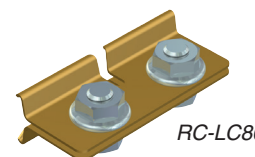
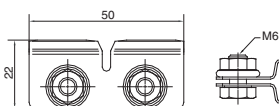

RC-LC80

Type RC-LC110

To be applied for mounting copper conductors Cu110. Click connection

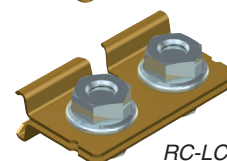
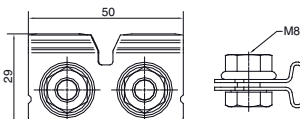

RC-LC110

Type RC-LC200

To be applied for mounting copper conductors Cu125, Cu160 and Cu200. Screwed connection.

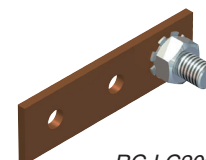
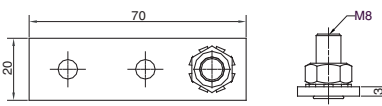

RC-LC200

Transition cables

Type OK25

Cable 1x 25 mm², length 1,5 m, with cable lugs. Max. current capacity 125A or 250A (2 cables in parallel connection) and Cu125 conductor. To be used with transition box OGV320 (see below).

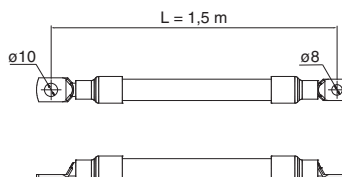

Type OK35

Similar to OK25, however for max. current capacity 320A (with 2 cables in parallel connection and Cu160 conductor).

Type OK50

Similar to OK25, however for max. current capacity 400A (with 2 cables in parallel connection and Cu200 conductor).

Transition cable series OK

Transition box for feed connection

Click-Ductor

Type OGV320

Complete with 2x5 bolts M10 for cable lug connections, 7 glands PG21 and a special grommet for cables of Ø20 - Ø75 mm .

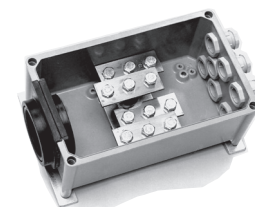
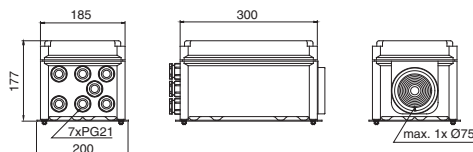

OGV320

LINE FEED CLAMPS	DESCRIPTION	NUMBER	max. current (A) 100% I.D.	with type line feed holder
AKAPP NO. 2109010	Feed clamp small RC-LC80	1 per conductor	80	RC-LCH
2109020	Feed clamp large RC-LC110	1 per conductor	110	RC-LCH
2109030	Feed clamp RC-LC200	1 per conductor	160	RC-LCH

TRANSITION CABLES	DESCRIPTION	NUMBER	max. current (A) (100% I.D.)	with type transition box
AKAPP NO. 1499560	Cable, 1x25 mm ² , L=1,5m OK25	1 per conductor	135	OGV320
1499640	Cable, 1x35 mm ² , L=1,5m OK35	1 per conductor	169	OGV320
1499720	Cable, 1x50 mm ² , L=1,5m OK50	1 per conductor	207	OGV320

TRANSITION BOX	DESCRIPTION	NUMBER	max. current (A) (100% I.D.)	protection degree
AKAPP NO. 1010510	Overgangskast OGV320	1 per system	286,3	IP44

Collector trolleys series C7/G: excellent contact characteristics!

The current conduction of the Click-Ductor to the device to be fed is effected through the collector trolley. The contact with the flat copper conductors is maintained uninterruptedly by means of flexible, extreme wear-resistant carbon brushes manufactured from a specific bronze-coal alloy. The collector trolley is pulled into the Click-Ductor by the moving machine to be fed and by means of a trolley towing arm mounted onto this machine. Traverse speeds **standard** up to **80 m/minute**, with **special 'GS' high speed trolleys** up to **200 m/minute** (see page 12).

The picture below shows the main characteristics of the collector trolley. It shows in brief why these trolleys are highly dependable and efficient.

On the next pages you'll find detailed information on the series collector trolleys and accompanying parts.

We also supply collector trolley assemblies, complete with transition box and towing arm.

Pages 15 shows an overview of all options.

The standard collector trolley with its specific characteristics:

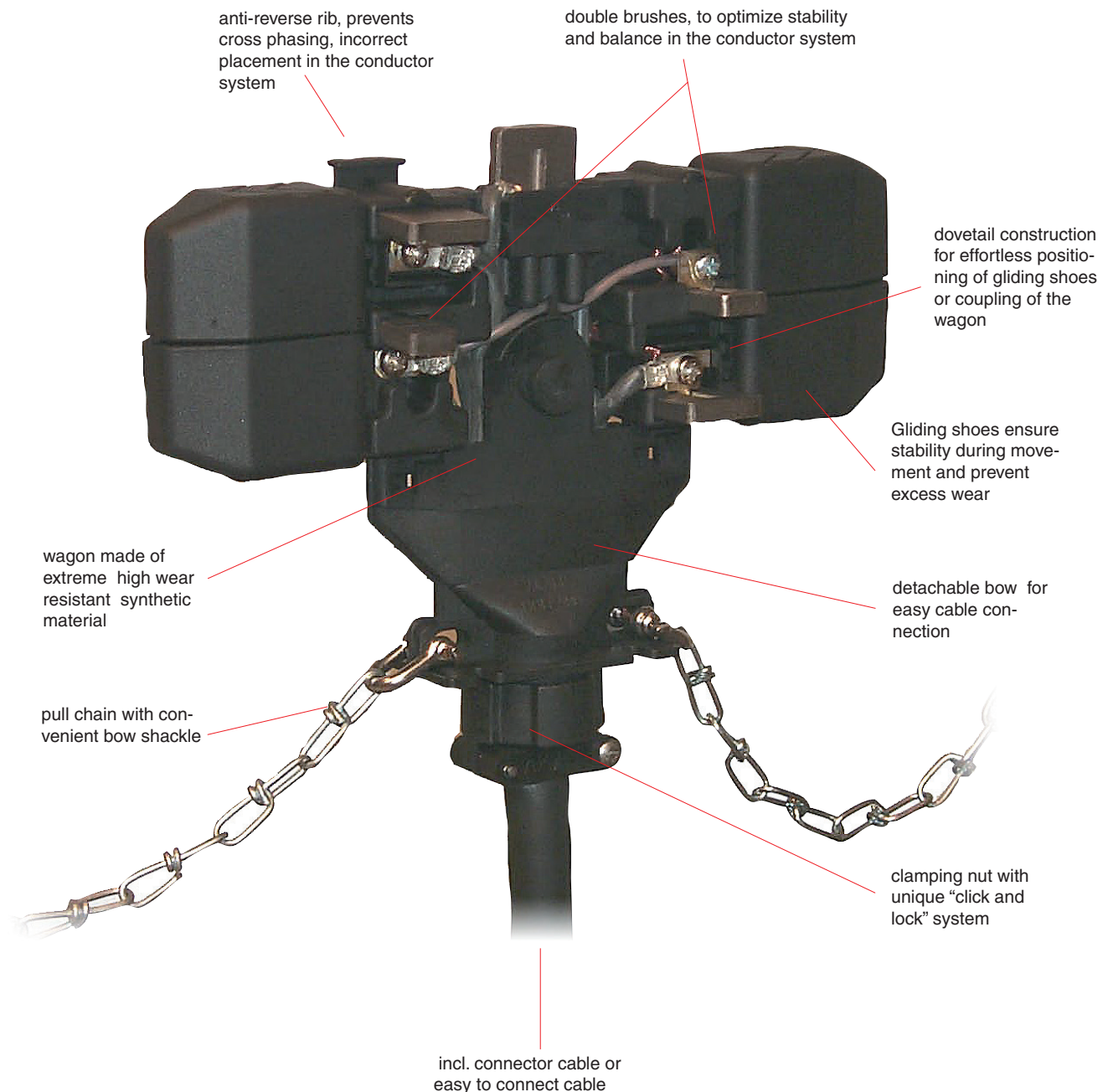

Collector trolleys: standard series for high performance

The collector trolleys are available for systems with 4, 5 or 7 conductors and suitable for nominal current capacities of 35A, 70A and 100A (DC 60%). Travel speed up to **80 m/min.**

The collector trolley series 'CL' are standard fitted with approx. 1m supply cable with numbered cores. Collector trolley series 'C' are delivered without cable.

The collector trolleys of these series can easily be adapted, e.g. linking 2 collector trolleys together for increasing the maximum current capacity.

C(L)7/G collector trolleys are equipped with wear-resistant gliding shoes, perfectly gliding over the surface of the rail housing and performing a very high stability of the collector trolley during moving.

C(L)7/GS collector trolleys are suitable for **high-speed** operation (up to 200 m/min.). Provided with extra long gliding shoes with integrated **wheel set**. An additional **middle wheel set** ensures maximum stability during travelling.

See picture, table below and selection chart on page 15.

Standard collector trolleys

Click-Ductor collector trolleys are available with 4, 5 or 7 poles with current carrying capacities of **35A, 70A and 100A** (duty cycle 60%). Applicable from -20°C up to +80°C (please note that the max. temperature of the Click-Ductor housing is +50°C).

These collector trolleys are fitted as standard with a supply cable. The connection with the apparatus/machine to be fed is via a transition box (ordered separately) which can be located adjacent to the collector trolley towing arm position.

Selection chart of standard collector trolleys + transition boxes

A max.	35		70		100	
number of poles	type no. collect.trolley	type no. trans. box	type no. collect.trolley	type no. trans. box	type no. collect.trolley	type no. trans. box
4	CL7-4-35/G	TTB35-4	CL7-4-70/G	TTB70-4	CL7-4-100/G	TTB100-4
5	CL7-5-35/G		CL7-5-70/G		CL7-5-100/G	
7	CL7-7-35/G	TTB35-7	CL7-7-70/G	TTB70-7	CL7-7-100/G	TTB100-7

When application of **2 separate collector trolleys per apparatus to be fed** (e.g. for transfer installations), the following transition boxes are used:

number of collector trolleys	collector trolley type	transition box type
2 collector trolleys	CL7-4-35/G	TTB70-4
2 collector trolleys	CL7-5-35/G or CL7-7-35/G	TTB70-7
2 collector trolleys	CL7-4-70/G or CL7-5-70/G	OG300-7
2 collector trolleys	CL7-7-70/G	OG300-7
2 collector trolleys	CL7-4-100/G	OG300-7
2 collector trolleys	CL7-5-100/G or CL7-7-100/G	OG300-7

For complete trolley assemblies with transition box and towing arm, please see the table on page 15.

Carbon brushes and gliding shoes

The collector trolleys are supplied as standard with carbon brushes for 35A, positioned according to the table below.

The brushes in positions 4 and 5 are both fitted as double brushes ("twin brushes"). Twin brushes are smaller than the others and their capacity is 35A per set. Advantages of this construction are a **perfect balanced** collector trolley.

Gliding shoes can very easily be mounted to the collector trolley by means of a dovetail construction. See also page 16. Per collector trolley 4 gliding shoes are required. There are special gliding shoes for **high-speed** applications (suffix 'GS').

CARBON BRUSH TYPES		Standard carbon brushes	
Application	Brush position in collector trolley	Art. no.	for normal conductors
Phase brush** norm.	1,2,3 and 6	1411021	K91P
Phase brush** twin	4 and 5	1410601	C91D
Ground brush	7	1410521	C91A
GLIDING SHOES		Art. no.	
Gliding shoe	4 pcs. per trolley	1331930	
Gliding shoe for 'GS'	4 pcs. per trolley	2130105.B0000	

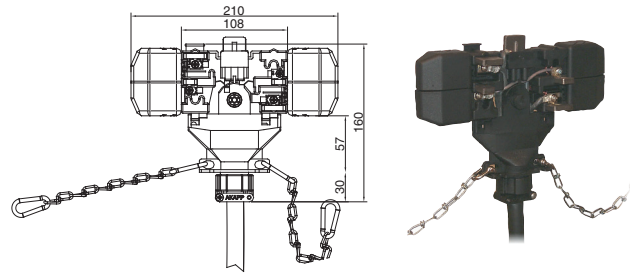

CL7-7-35/G

CL7-7-35/G

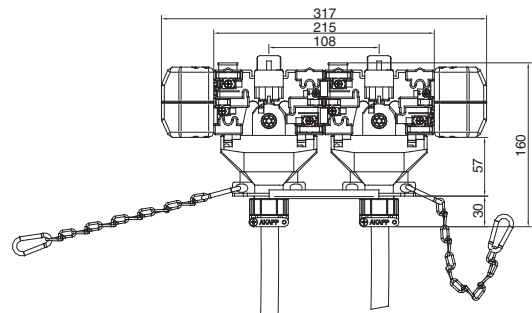

CL7-7-70/G

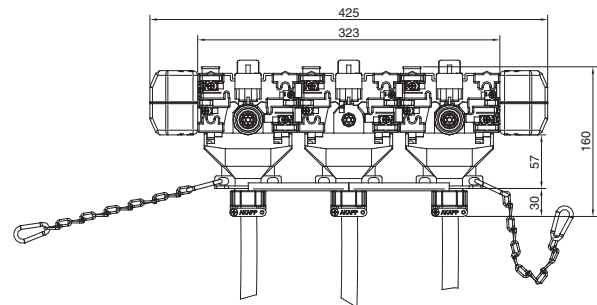

CL7-7-100/G

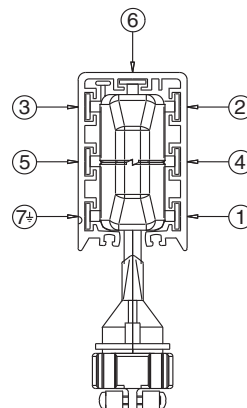

Schedule brush positions in CL7../G



CL7-7-35/GS

Gliding shoe with wheel set for type 'GS'-collector trolleys

Collector trolleys series CL4-40/G: the compact solution for double brushes per phase

AKAPP offers the possibility to use a singular collector trolley, type CL4-40/G, with double brushes. This trolley applies to the IEC 60204.32.13.8.2 standard, describing the situations whereas conductor bar systems need to apply double carbon brushes.

The CL4-40/G trolley is an excellent and very cost effective solution for those cases whereas the above standard is applied. In addition, the CL4-40 will improve the cost effectiveness of systems that are controlled by frequency inverters.

The CL4-40/G is a 4 pole trolley, capacity 40 Amps at 60% duty cycle. Applicable from -20°C up to +80°C (attention: the max. temperature of the Click-Ductor housing is +50°C).

The CL4-40/G uses twin carbon brushes C91D for phases and special twin ground brushes C91DA.

All CL4-40/G trolleys are available with cable lengths of 1m (standard), 2m, 3m, 4m or 5m.

For cable lengths other than 1m, add /2M, /3M, /4M or /5M to the type description.

Standard collector trolleys

Type CL4-40/G

4-pole trolley with standard wheels. Max. speed 80 m/min.
For all RC-types of housings.
Standard fitted with 1m cable.

Note: Trolleys without cable are also possible. Please cancel the "L" in the type description; e.g. type 'C4-40' is a 40 Amps trolley without cable.

The table below shows an overview of available collector trolley types with the respective article numbers.

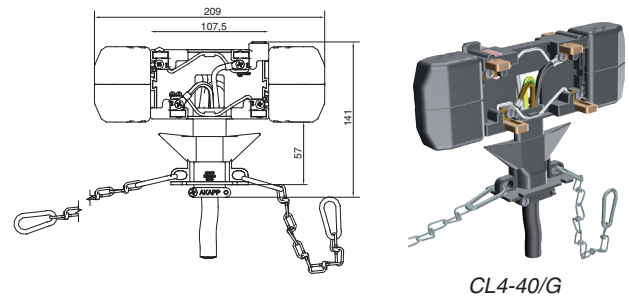

CL4-40/G

Collector trolley assemblies

Type CL4-40/G/BMV/TTB (art. no. 1088650)

For easy ordering, we created a fully assembled version of the collector trolley CL4-40/G, complete with towing arm BMV35 and trolley transition box TTB35. See table below for order reference. For dimensions see table on page 14 (top).

Carbon brushes and gliding shoes

The following parts are applicable:

AKAPP NO.	DESCRIPTION	TYPE
1410601	Carbon brush twin phase	C91D *)
1410631	Carbon brush twin ground	C91DA
1331930	Gliding shoes	---

*) similar as on CL7 collector

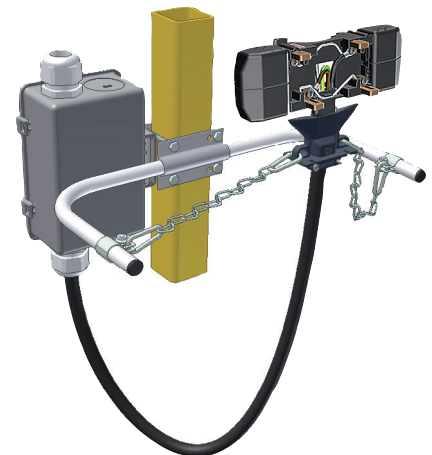

CL4-40/G/BMV/TTB

Available collector trolleys

AKAPP NO.	DESCRIPTION	EXTENSION	max In (ID=100%) (A)	number of poles	max. speed m/min.
1088610	Collector trolley + cable CL4-40/G		31,00	4	80
1088610.B0002	Collector trolley + cable CL4-40/G	/2M	31,00	4	80
1088610.B0003	Collector trolley + cable CL4-40/G	/3M	31,00	4	80
1088610.B0004	Collector trolley + cable CL4-40/G	/4M	31,00	4	80
1088610.B0005	Collector trolley + cable CL4-40/G	/5M	31,00	4	80
1088650	Collector trolley CL4-40/G/BMV/TTB		31,00	4	80

Accessoires for collector trolleys: towing arms, transition boxes

A towing arm is attached to the moving machinery and connected to the collector trolley via chains.

The arrangement is such that when pulling in either direction one of the collector towing chains is taut, the other remaining slack. In this way lateral movements of the crane, hoist, etc. are not transmitted to the trolley.

This tolerance provides ultimate **security of service!**

Attention: The towing connector on the arm should be installed 10 - 30 mm lower than the towing connection on the trolley and should be aligned directly below the housing opening in the vertical plane.

A transition box can be mounted on the towing arm or close by the apparatus/machine. This unit facilitates the connection of the flexible cable from the collector trolley with the fixed wiring from the apparatus/machine being fed.

Standard performances towing arms

Type BMV35 for collector trolleys 35A/40A

Type BMV70 for collector trolleys 70A

Type BMV100 for collector trolleys 100A

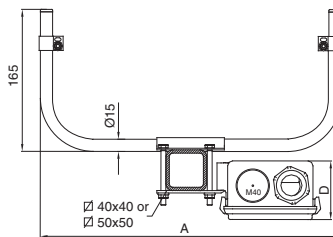

	BMV35 + TTB35	BMV70 + TTB70	BMV100 + TTB100
A	370	505	640
B	175	175	195
C	115	115	160
D	70	70	80
In	1xM32	2xM32	3xM32
Out	1xM32	1xM40	1xM40

Types of transition boxes for collector trolleys

type no. transition box	dimensions l x w x h mm	connecting terminals	cable inlet
TTB35-4 and TTB35-7	175x115x70	4 pc. 4 mm ²	2 glands M32
		7 pc. 4 mm ²	
TTB70-4 and TTB70-7	175x115x70	4 pc. 10 mm ²	2 glands M32 1 gland M40
		7 pc. 10 mm ²	
TTB100-4 and TTB100-7	195x160x80	4 pc. 16 mm ²	3 glands M32 1 gland M40
		7 pc. 16 mm ²	
TTB140-4-2	195x160x80	4 pc. 35 mm ²	2 glands M32 1 gland M50
OG300-7	300x190x180	7 pc. bolts M10	6 glands PG21 1 special inlet 20-70 mmØ

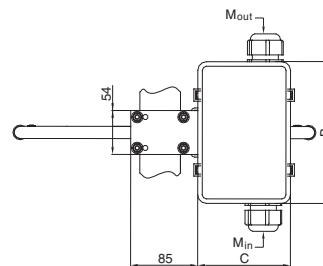

BMV + TTB

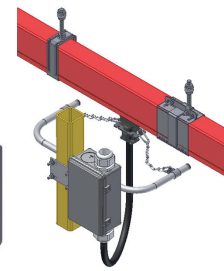

BMV35 + TTB35-4

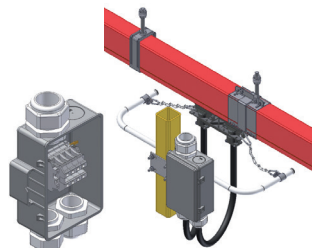

BMV70 + TTB70-4

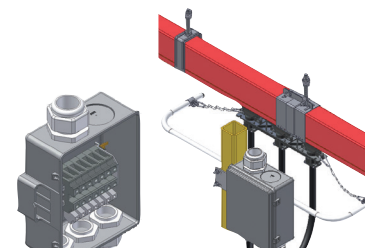

BMV100 + TTB100-7

The box types TTB35 up to TTB140 can be mounted directly on the fastening clamp of the towing arm type BMV. The box type OG300 is supplied with a mounting plate, which ensures easy mounting of this box to the apparatus to be fed.

Overview standard collector trolleys, towing arms and transition boxes

In the chart below **on the left** you can view the most common standard collector trolleys of the series CL7-../G and CL4-40/G. The AKAPP reference numbers and some details are listed for each type.

This overview however does not show all possibilities. For further information on this, we recommend you to contact your AKAPP-STEMMANN supplier.

In the chart below **on the right** you can view the standard collector trolleys of the series CL7-../GS, for high speed operation. See also page 12 for more details. The AKAPP reference numbers and some details are listed for each type.

The other charts show all towing arms and transition boxes including their reference numbers.

Selection chart collector trolleys

(v_{max} 80m/min.)

AKAPP NO.	DESCRIPTION	EXTENSION	max In (DC=60%) (A)	NUMBER OF POLES
1093505.B0000	Collector trolley + cable CL7-4-35/G		35	4
1093505.B0002	Collector trolley + cable CL7-4-35 /G	/3M	35	4
1093505.B0003	Collector trolley + cable CL7-4-35/G	/5M	35	4
1093510.B0000	Collector trolley + cable CL7-4-35/G	/2M	35	4
1093510.B0020	Collector trolley + cable CL7-5-35/G	/2M	35	5
1093530.B0003	Collector trolley + cable CL7-5-35/G	/5M	35	5
1093650.B0024	Collector trolley + cable CL7-7-35 /G	/3M	35	7
1093650.B0033	Collector trolley + cable CL7-7-35 /G	/5M	35	7
1093712	Collector trolley + cable CL7-7-35/G		35	7
1093920.B0000	Collector trolley + cable CL7-4-70/G	/2M	70	4
1093925.B0000	Collector trolley + cable CL7-4-70 /G		70	4
1093925.B0002	Collector trolley + cable CL7-4-70 /G	/3M	70	4
1093925.B0003	Collector trolley + cable CL7-4-70 /G	/5M	70	4
1097570.E0000	Collector trolley + cable CL7-5-70/G		70	5
1094070.B0012	Collector trolley + cable CL7-7-70 /G	/3M	70	7
1094070.B0014	Collector trolley + cable CL7-7-70/G	/5M	70	7
1094132	Collector trolley + cable CL7-7-70/G		70	7
1094200	Collector trolley + cable CL7-4-100/G		100	4
1094210	Collector trolley + cable CL7-4-100/G	/2M	100	4
1094220	Collector trolley + cable CL7-4-100/G	/5M	100	4
1094400	Collector trolley + cable CL7-7-100/G		100	7
1094410	Collector trolley + cable CL7-7-100/G	/2M	100	7
1094420	Collector trolley + cable CL7-7-100/G	/5M	100	7
1088610	Collector trolley + cable CL4-40/G		40	4
1088610.B0002	Collector trolley + cable CL4-40/G	/2M	40	4
1088610.B0003	Collector trolley + cable CL4-40/G	/3M	40	4
1088610.B0004	Collector trolley + cable CL4-40/G	/4M	40	4
1088610.B0005	Collector trolley + cable CL4-40/G	/5M	40	4

Collector trolley assemblies with transition box and towing arm

AKAPP NO.	DESCRIPTION	EXTENSION	max In (A) (DC=60%)	NUMBER OF POLES
1093505.B0001	Collector trolley + cable CL7-4-35 /G	/BMV/TTB	35	4
1093712.B0001	Collector trolley + cable CL7-7-35 /G	/BMV/TTB	35	7
1093925.B0001	Collector trolley + cable CL7-4-70 /G	/BMV/TTB	70	4
1094132.B0001	Collector trolley + cable CL7-7-70 /G	/BMV/TTB	70	7
1094300	Collector trolley + cable CL7-4-100/G	/BMV/TTB	100	4
1094500	Collector trolley + cable CL7-7-100/G	/BMV/TTB	100	7
1088650	Collector trolley + cable CL4-40/G	/BMV/TTB	40	4

Selection chart collector trolleys

(high speed, v_{max} 200m/min.)

AKAPP NO.	DESCRIPTION	max In (DC=60%) (A)	NUMBER OF POLES
1093500.B0000	Collector trolley + cable CL7-4-35/GS	35	4
1093565.B0000	Collector trolley + cable CL7-5-35/GS	35	5
1093645.B0000	Collector trolley + cable CL7-7-35/GS	35	7
1093500.B0001	Collector trolley + cable CL7-4-70/GS	70	4
1093565.B0001	Collector trolley + cable CL7-5-70/GS	70	5
1093645.B0005	Collector trolley + cable CL7-7-70/GS	70	7
1093500.B0002	Collector trolley + cable CL7-4-100/GS	100	4
1093565.B0002	Collector trolley + cable CL7-5-100/GS	100	5
1093645.B0010	Collector trolley + cable CL7-7-100/GS	100	7

Selection chart towing arms

AKAPP NO.	DESCRIPTION	COLLECTOR TROLLEY
1019050	Towing arm BMV35	...35/...40
1019130	Towing arm BMV70	...70
1019210	Towing arm BMV100	...100
1018940	Towing arm, stainl.st. BMV35-R	...35
1019830	Towing arm, stainl.st. BMV70-R	...70
1019910	Towing arm, stainl.st. BMV100-R	...100

Selection chart transition boxes

AKAPP NO.	DESCRIPTION
1020000	Transition box for collector trolleys TTB35-4
1020010	Transition box for collector trolleys TTB35-7
1020020	Transition box for collector trolleys TTB70-4
1020030	Transition box for collector trolleys TTB70-7
1020040	Transition box for collector trolleys TTB100-4
1020050	Transition box for collector trolleys TTB100-7
1020060	Transition box for collector trolleys TTB140-4-2
1010430	Transition box for collector trolleys OG300-7

AKAPP Click-Ductor® system: efficiency per linear meter!

By using AKAPP Click-Ductor, you save on costs. This starts and is evident, immediately during installation. All components are adapted to one another, as a result of which the components can be applied easily.

Ensure an even easier task and have our Technical Service install all, quickly and with expertise!

The fast experience and know-how of the material involved guarantees an optimal functioning installation.

You would prefer advice on your installation first? No problem, our advisors can assist you with all your questions, free of charge and no strings attached !

No technique without maintenance! Maintenance is however kept at a minimum and when you decide on a contract via our Technical Service, we will periodically perform the maintenance for you. As a result of such a contract, maintenance is out of your hands!

Support brackets with pre-mounted sliding hangers

AKAPP Multiconductor can easily be fastened to a profiled beam. In most cases the standard support brackets (available in various lengths) will suffice. These bolt connections are to be applied and adjusted easily.

A selection of support brackets can also be supplied with pre-mounted sliding hangers. This reduces the mounting time on site considerably!

The table below shows the available support bracket types with pre-mounted sliding hangers. For performances and dimensions see page 5.

AKAPP NO.	DESCRIPTION	length (mm)
1018011.B0000	Support bracket UH330/BN7-Z pre-mounted, slot up	330
1018011.B0001	Support bracket UH330/BN7-Z pre-mounted, slot down	330
1018011.B0002	Support bracket UH330/BN7-L pre-mounted, slot up	330
1018011.B0003	Support bracket UH330/BN7-L pre-mounted, slot down	330
1018161.B0000	Support bracket UH500/BN7-Z pre-mounted, slot up	500
1018161.B0001	Support bracket UH500/BN7-Z pre-mounted, slot down	500
1018161.B0002	Support bracket UH500/BN7-L pre-mounted, slot up	500
1018161.B0003	Support bracket UH500/BN7-L pre-mounted, slot down	500
1018321.B0000	Support bracket UH700/BN7-Z pre-mounted, slot up	700
1018321.B0001	Support bracket UH700/BN7-Z pre-mounted, slot down	700
1018321.B0002	Support bracket UH700/BN7-L pre-mounted, slot up	700
1018321.B0003	Support bracket UH700/BN7-L pre-mounted, slot down	700

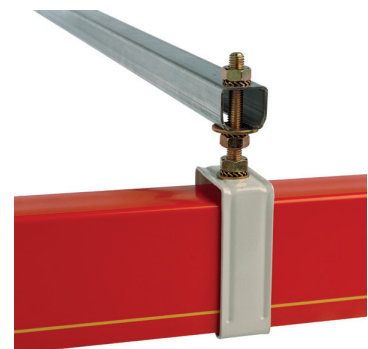

The AKAPP support brackets are of the type 'universal fitting' and easy to position and adjust!

Inspection of the collector trolley

Wabtec Netherlands has ensured that the inspection of the conductor trolley can be effected quickly.

All vital components of the conductor trolley are to be replaced in a trice!

The carbon brushes are marked, this marking indicates if and when exchange is required. Due to the smooth surface of the conductors and the absence of the plug connectors, the wear of the carbon brushes minimal!

The gliding shoes are made of a high quality and wear-resistant synthetic material and require virtually no maintenance, if standard operational conditions apply. Provided with marking stripes for visual inspection of the wear (see photo).

Visual inspection of carbon brushes is rather simple due to the markings as applied.

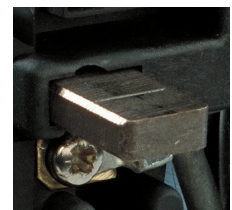

The gliding shoes can quickly and easily be positioned due to the dovetail construction. A visual inspection is possible, for a marking is provided.



Configuration of Click-Ductor systems: important remarks

Click-Ductor systems offer a high level of mounting flexibility. You can determine the most suitable location of the feed point (end- or line feed), considering the local situation and voltage drop.

The minimum mounting height (from the surface to the top of the collector trolley) is 250 mm.

Support distances up to 2.032 metre are possible.

The graphics below show the typical configuration options for RC4 and RC7 systems.

① Rail profile type RC4/RC7, End feed, support distance 1355 mm

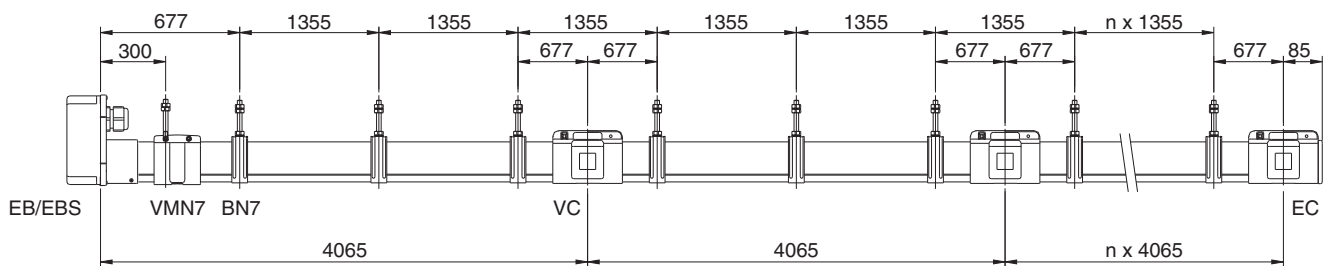

② Rail profile type RC4/RC7, Line feed, support distance 1355 mm

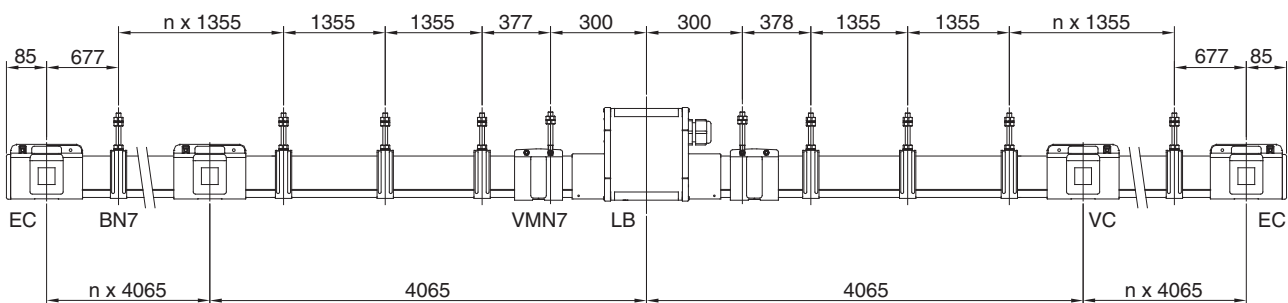

③ Rail profile type RC4/RC7, End feed, support distance 2032 mm

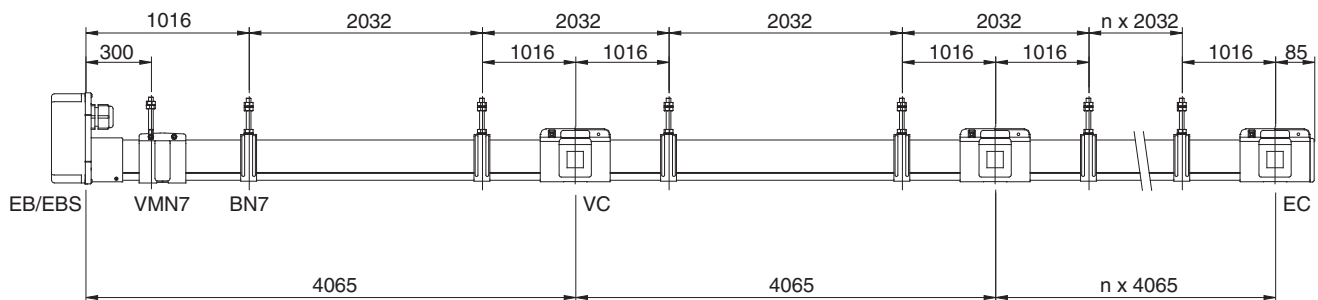

④ Rail profile type RC4/RC7, Line feed, support distance 2032 mm

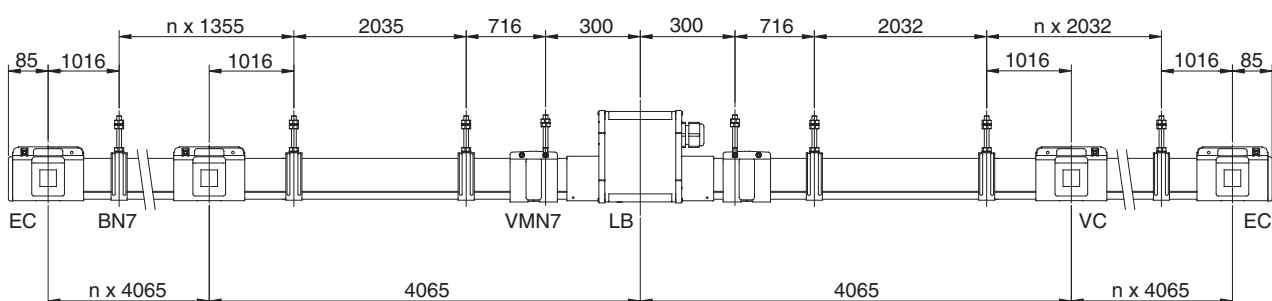

More on Click-Ductor: technical data and ordering references

General technical data

Nominal voltage: 690 Volt (CE/CCC appr.) / 600 Volt (UL appr.).

For further technical details refer to the components description in this catalogue.

Comprehensive installation instructions will accompany every AKAPP-STEMMANN conductor system.

System extensions

It is generally possible to increase the length of an existing system utilising standard components. Please consult your AKAPP-STEMMANN supplier for more information if required.

Design and dimensions

We reserve the right to amend dimensions/design of components in the interests of design advancement without prior notification.

Example for ordering indoor system

1 AKAPP Click-Ductor type RC4-4-50, 3 phase + ground, without flexible sealing strips, track length 50 m, 4 poles, nominal capacity up to 50A, duty cycle 80%, with end feed.

Apparatus to be fed: 1 overhead crane, maximum total power 7,5 kW, 400V, speed 40 m/min, in warehouse, dry, no excessive dust, ambient temperatures from +10°C up to +35°C.

Supports every 2.032 m.

The installation consists of the components according to the table beside.

AKAPP NO.	TYPE	DESCRIPTION	QUANT (pcs)
2101075.B0000	RC4-4-50/4M	Conductor bar grey, 4 pole, 50 A	12
2105720	EC4	End cap, grey	1
2109000	RC-EC80	End feed clamp 50-80A	4
1006830	EBS32	End feed box, small with 1xM32	1
2105450	Cu-C	Copper clamp for RC	44
2105400	VC	Joint cover for RC, IP23	12
1004960	VMN7-Z	Fixed point clamp, galvanised	1
1018011.B0001	UH330/BN7-Z	Support bracket 330 mm + Sliding hanger, galvanised, pre-mounted, slot down	24
1093505.B0000	CL7-4-35/G	Collector+cable for RC, 35 A, 4-pole with gliding shoes	1
1020000	TTB35-4	Trolley transition box	1
1019050	BMV35	Towing arm	1
and recommended additional components:			
1018010	UH330	Support bracket 330 mm, galv.	1

Example for ordering outdoor system

1 AKAPP Click-Ductor type RC7-7-200, 3 phase (parallel) + ground, with flexible sealing strips, track length 85 m, 7 poles, nominal capacity up to 346A, duty cycle 80%, with line feed at 24 m.

Apparatus to be fed: 2 cranes, 100kW each, 400V, speed 60 m/min, in concrete industry, alternate dusty and humid, ambient temperatures from -15°C up to +35°C.

Supports every 1.355 m.

The installation consists of the components according to the table beside.

AKAPP NO.	TYPE	DESCRIPTION	QUANT (pcs/m)
2110480	RC7-7-200/4M	Conductor bar red, 7 pole, 200A	21
2105710	EC7	End cap, red	2
2109050	RC- LCH	Line feed clamp holder	1
1006930	LB32-7	Line feed box with 7xM25	1
2109030	RC-LC200	Line feed connection 125-200A	7
1006960		Line feed Box Extension	1
1018161.B0003	UH500/BN7-L	Support bracket 500 mm + Sliding hanger, epoxy coated, pre-mounted, slot down	63
2105420	VC-IP44	Joint cover for RC, IP44	21
1005070	VMN7-L	Fixed point clamp, epoxy coated	2
1004030	AS7-C	Sealing strip chloroprene	170
1094400	CL7-7-100/G	Collector trolley+cable, 7 pole, 100A, with gliding shoes	2
1010120	OG200-5	Trolley transition box	2
1019210	BMV100	Towing arm	2
and recommended additional components:			
1020130	FTB400	Feed transition box	1
1018160	UH500	Support bracket 500 mm, galv.	2
1499720	OK50	Cable, 1 x 50 mm ² , 1,5 m length with 2 cable lugs	7

Other AKAPP conductor bar systems: always the perfect solution!

The AKAPP Click-Ductor is an ultimate reliable and efficient conductor system, which is world-wide, successfully used in indoor and outdoor installations. This brochure details a brief outline of the unique characteristics. However, Wabtec Netherlands supplies many conductor systems, a fitting solution for the most diverse situations.

Wabtec Netherlands aims to provide all information you need: our professional team is available for free and non committal advice.

Further information required? Just a single telephone call, fax or e-mail will suffice. See the front cover for details or check www.akapp.com to find your nearest distributor.

Multiconductor

A compact and multi purpose conductor system. The **uninterrupted** conductors ensure a perfect transmission of **current feed-** as well as **control-** and **data signals**. Current capacities up to 320A. A flexible rubber sealing prevents penetration of dust or liquids. Well suited for extremely long tracks and high travel speeds.

Used world-wide for cranes, traverse cars, (automated) warehouses, elevators, textile production, sluices, trains etc., even under in extremely dusty, humid or even corrosive environments!

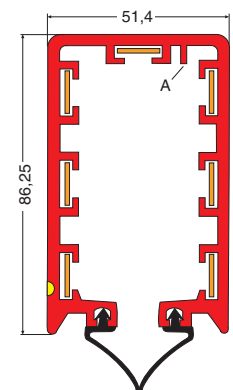
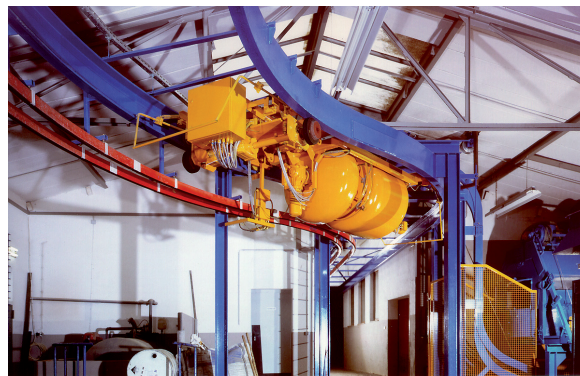

4-Ductor

If four conductors suffice, no flexible rubber sealing is required, but you do want to make use of all the advantages of the uninterrupted conductors, opt for the most ideal conductor system for your organisation, opt for the AKAPP 4-Ductor!

Ideal, for it has: no expansion problems, a constant and low voltage loss, a choice of 5 current intensities (see above) and virtually no maintenance. In all, an uninterrupted current supply for a variety of movable and/or mobile equipment at a **very profitable cost-benefit analysis**.

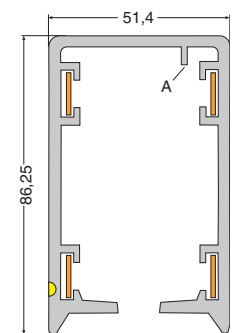

Pro-Ductor

The most compact, varied conductor system for automated warehouses and many other applications! Suitable for up to 4 copper conductors (PR4), up to 7 copper conductors (type PR7), or up to 10 copper conductors (type PR10).

The p.v.c. housing PR7 has a height of only 147 mm and is 27 mm wide and can be applied only centimetres above floor level. The **uninterrupted** conductors ensure a perfect transmission of both **feed, control and data signals**. Suitable for **extreme long travelling lengths** and **high travel speeds**.

Choices in current capacity from 50A, 80A, 125A, 160A up to 200A (80% D.C.).

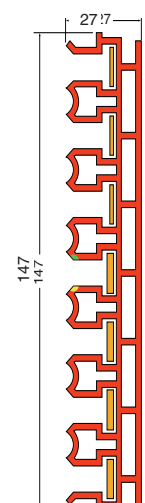

Wabtec Netherlands: Flexible with energy!

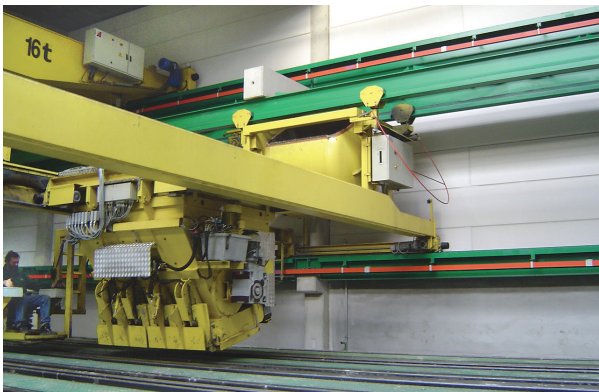

Wabtec Netherlands is a market leader with our made to order conductor bar systems. We offer you the best possible solution for almost any application in whatever the circumstances. Multipole and single pole systems available. We welcome your inquiries!



Our festoon systems offer the most flexible solutions for transporting flat or round cables and hoses. A wide variety of profiles and components guarantees reliable installations, adapted to the environment.



The AKAPP products are designed by the highest standards and are certified by UL, CCC and CE.

More information on our products can be found in our brochures, which we are happy to send you on request. Or visit our website www.akapp.com, where you can find more relevant information, download brochures and make online inquiries; fast and easy!

