

TOP

Rotary limit switch



UK Distributor



Tel: 0115 932 7010 | Email: sales@metreel.co.uk
www.metreel.co.uk

Rotary limit switch used to control and measure the movement of industrial machines or the position of the nacelle or pitch angle of wind turbines. Salt mist resistant and rich in options, Top is designed to meet the most demanding requirements.

FEATURES

- It consists of a gear motor that transfers movement to the cams and the other movement detection devices through a primary input reduction stage (worm gear and helical toothed gear) and one or more secondary output stages (pairs of straight toothed gears).
- Accurate adjustment of cams by means of screws.
- Positive opening NC contacts for safety functions.
- Mechanical life of switches: up to 10 million operations.
- IP protection degree: Top is classified IP66, IP67 and IP69K.
- NEMA protection degree: Top is classified Type 4X*.
- Extreme temperature resistance: -40°C to +80°C.
- Salt mist resistant.
- It features base and cover made of electrostatic varnished die-cast aluminum, transmission and gear driving shafts made of stainless steel AISI 303, worm gear transmission shaft rotating on ball bearings, self-lubricating technopolymer gears and driving bushes.
- All materials and components used are wear resistant and guarantee protection of the unit against water and dust.

OPTIONS

- Revolution ratios from 1:1 to 1:8100, achieved by combining different secondary output stages.
- Each of the three outputs can be set to a different revolution ratio to enable diversified control of the machine when special requirements need to be met.
- Snap action switches with 1NO+1NC contacts or slow action switches with 1 NC contact.
- It can be equipped with 3 cam sets (with up to 15 switches), potentiometers and encoders (alone or on top of cam sets

- with up to 2 switches), Egon 36-AL absolute encoders (alone or on top of cam sets with up to 2 switches) and Yankee absolute encoders (on top of cam sets with up to 4 switches).
- XL version featuring cover rise available with 3 cam sets (with up to 18 switches), potentiometers and encoders (alone or on top of cam sets with up to 5 switches), Egon 36-AL absolute encoders (alone or on top of cam sets with up to 4 switches) and Yankee absolute encoders (on top of cam sets with up to 6 switches).
- Dedicated cable clamps or connectors.
- Available with anti-moisture plug fitted to the base by means of a lock nut, to improve transpiration for the limit switch while maintaining protection against water.
- Available with flanges, pinion gears and couplings.
- Plates with universal adapter to replace existing systems.

CERTIFICATIONS

- CE marking, cULus* marking and EAC certification.
- Top is available, upon request, with the SIL1 certification (Safety Integrity Level 1), according to Standard IEC 61508.
- Complying with accident prevention regulation BGV C 1 (only for Germany).

Use the online configurator (<https://configuratore.terworld.com>) or fill in the "request form" for accurate product configuration.

* Not available on all versions.

POSSIBLE ASSEMBLIES

Top XL with cover rise



With anti-moisture plug

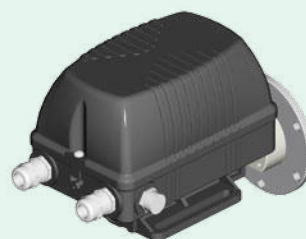

CERTIFICATIONS

Conformity to Community Directives	2014/35/UE Low Voltage Directive
	2006/42/CE Machinery Directive
Conformity to CE Standards	EN 60204-1 Safety of machinery - Electrical equipment of machines
	EN 60204-32 Safety of machinery - Electrical equipment of machines - Requirements for hoisting machines
	EN 60947-1 Low-voltage switchgear and controlgear
	EN 60947-5-1 Low-voltage switchgear and controlgear - Control circuit devices and switching elements - Electromechanical control circuit devices
Conformity to cULus Standards	EN 60529 Degrees of protection provided by enclosures
	CSA-C22.2 No 14-13 Industrial Control Equipment
	UL 508 Industrial Control Equipment
SIL1	IEC 61508:2010 Part 2-4-6-7 Functional safety of electrical/electronic/programmable electronic safety-related systems
BGV C 1	Regulations for the prevention of accidents BGV C 1 (only for Germany)
Markings and homologations	CE cULus* EAC

GENERAL TECHNICAL SPECIFICATIONS

Ambient temperature	Storage -40°C/+80°C**
	Operational -40°C/+80°C**
IP protection degree	IP 66/IP 67/IP 69K
NEMA protection degree	Type 4X*
Insulation category	Class I
Maximum rotation speed	800 rpm
Cable entry	Cable clamp M20
Shafts	Stainless steel AISI 303

* Not available on all versions.

** Cam sets with components suitable for high temperature up to +100°C. Attention: sets with 6 cams always feature components suitable for -40°C / +100°C.

TECHNICAL SPECIFICATIONS OF THE SWITCHES

Code	PRSL0110XX	PRSL0111XX
Utilisation category	AC 15	
Rated operational voltage	250 Vac	
Rated operational current	3 A	
Rated thermal current	10 A	
Rated insulation voltage	300 Vac	
Mechanical life	10x10 ⁶ operations	
Connections	Screw-type terminals	
Wires	1x2.5 mm ² , 2x1.5 mm ² (UL (c)UL: use 60°C or 75°C copper (CU) conductors and stiff or flexible wire 14-22 AWG)	
Tightening torque	0.5 Nm	
Microswitch type	Double break, snap action	Double break, slow action
Contacts	1NO+1NC (All NC contacts are of the positive opening operation type \ominus)	1NC (All NC contacts are of the positive opening operation type \ominus)
Scheme		
Markings and homologations	CE cULus EAC	

Switches PRSL0100XX available on request.

TECHNICAL SPECIFICATIONS OF THE POTENTIOMETERS

Code of potentiometer with support	PA020001	PA020002
Ohmic value	10 k Ω	10 k Ω mechanical stop
Resolution	Infinite	
Independent linearity	$\pm 1\%$	
Life time	10x10 ⁶ movements	
Operational ambient temperature	-55°C/+105°C	
Continuous rotation (without stop)	360°	
Continuous rotation (with stop)	333° $\pm 5^\circ$	
Actual electrical angle	310° $\pm 5^\circ$	
Ohmic value tolerance	$\pm 20\%$	

Code of potentiometer with support	PA020003	PA020004	PA020005
Ohmic value	10 k Ω	10 k Ω	5 k Ω
Connections	4 turrets	3 turrets	4 turrets
Independent linearity (over AEA -3°)	$\leq \pm 1\%$	$\leq \pm 0.35\%$	$\leq \pm 1\%$
Life time	5x10 ⁶ movements		
Operational ambient temperature	-55°C/+125°C		
Mechanical angle	360° continuous		
Actual Electrical Angle (AEA)	340° $\pm 5^\circ$		
Ohmic value tolerance	Max $\pm 20\%$ at 20°C	Max $\pm 10\%$ at 20°C	Max $\pm 20\%$ at 20°C

Code of potentiometer with support	PA020006	PA020007	PA020008
Ohmic value	4.7 kΩ	10 kΩ	2.2 kΩ
Independant linearity (ref. AEA -3°)	±0.25%		
Life time	3x10 ⁶ movements		
Operational ambient temperature	-55°C/+125°C		
Mechanical angle	360° continuous		
Actual Electrical Angle (AEA)	355°±5°		
Ohmic value tolerance	±5%		
Temperature drift	< 50 PPM/°C		

Code of potentiometer with support	PA020009
Ohmic value	2 kΩ
Resolution	Better then 0.008°
Linearity	±0.075%
Independant linearity	±0.075%
Life time	100x10 ⁶ movements
Operational ambient temperature	-40°C/+100°C
Mechanical angle	360° continuous
Actual electrical travel	350° ±2°
Ohmic value tolerance	±20%

TECHNICAL SPECIFICATIONS OF THE ENCODERS

Code with support	PA030001	PA030002
Resolution	36 pulses/rev.	150 pulses/rev.
Operational ambient temperature	-40°C/+85°C	
Code	Incremental	
Supply voltage	4.5 Vdc min. to 30 Vdc max. (35 mA max. - no load)	
Output voltage	Low: 500 mV max. at 10 mA High: (Vin - 0.6) at -10 mA (Vin - 1.3) at -25 mA	
Output current	25 mA max. load per output channel	
Output format	Two channel (A, B) quadrature with Index (Z)	
Phase sense	A leads B clockwise (CW) from the mounting end of the encoder	
Accuracy	+/- 0.8 arc-min.	
Outputs	Push pull	
Electrical protection	Protection against reverse polarity and output short-circuit	

CERTIFICATIONS OF THE ABSOLUTE ENCODER EGON 36-AL

Conformity to Community Directives	2014/35/UE Low Voltage Directive (LVD)
	2006/42/CE Machinery Directive
Conformity to CE Standards	EN 60204-1 Safety of machinery - Electrical equipment of machines
	EN 60947-1 Low-voltage switchgear and controlgear
	EN 60947-5-1 Low-voltage switchgear and controlgear - Control circuit devices and switching elements - Electromechanical control circuit devices
	EN 60529 Degrees of protection provided by enclosures
Markings and homologations	EN 61000-6-2 , EN 61000-6-4 , EN 61000-4-2 , EN 61000-4-3 , EN 61000-4-4 , EN 61000-4-5 , EN 61000-4-6 Electromagnetic compatibility
	CE pending

GENERAL TECHNICAL SPECIFICATIONS OF THE ABSOLUTE ENCODER EGON 36-AL

Ambient temperature	Storage -30°C/+80°C
	Operational -30°C/+80°C
IP protection degree	IP42
Shaft diameter	6 mm

ELECTRICAL SPECIFICATIONS OF THE ABSOLUTE ENCODER EGON 36-AL

Power supply	12...30 Vdc
	Current 4...20 mA
Analog output	Voltage 1...5 V
	Voltage 2...10 V
Consumption	35 mA simple version
	55 mA redundant version
Single-turn resolution	12 bit (4096 points for revolution)
Protection against input/output over-current	Yes
Protection against input/output over-voltage	Yes
Accuracy	± 0.5%
Linearity	± 0.25%
Redundancy	2 offset outputs (analog)

CERTIFICATIONS OF THE ABSOLUTE ENCODER YANKEE

Conformity to Community Directives	2014/30/UE Electromagnetic Compatibility (EMC) Directive
	2006/42/CE Machinery Directive
	2014/35/UE Low Voltage Directive (LVD)
Conformity to CE Standards	EN 61326-1 Electrical equipment for measurement, control and laboratory use - EMC requirements
	EN 60529 Degrees of protection provided by enclosures
Conformity to cULus Standards	CSA-C22.2 No 14-13 Industrial Control Equipment
	UL 508 Industrial Control Equipment
Markings and homologations	CE 

GENERAL TECHNICAL SPECIFICATIONS OF THE ABSOLUTE ENCODER YANKEE

Ambient temperature	Storage -40°C/+80°C
	Operational -40°C/+80°C
IP protection degree	IP 20
Free rotation	360°
Maximum rotation speed	800 rpm

ELECTRICAL SPECIFICATIONS OF THE ABSOLUTE ENCODER YANKEE

Code	PA01AA01	PA01AB01	PA01AC01
Analog output	Current 4 ÷ 20 mA	Voltage 0 ÷ 10 V	PWM 0 ÷ 100 %
Power supply	12 ÷ 48 Vdc/12 ÷ 48 Vac		
Protection against reverse polarity	Yes		
Absorption	50 mA		
Resolution	10 bit		
Linearity	+/- 0.5°		
Max. hysteresis	0.1°		
Zero Point setting	Through button/wire		
Signal increment direction	CW (standard)/CCW (on request)		
Connections	Terminal board		
Terminal wires	0.14 mm ² - 1.5 mm ²		
Terminal tightening torque	0.22 Nm - 0.25 Nm		

OVERALL DIMENSIONS (mm)

Standard

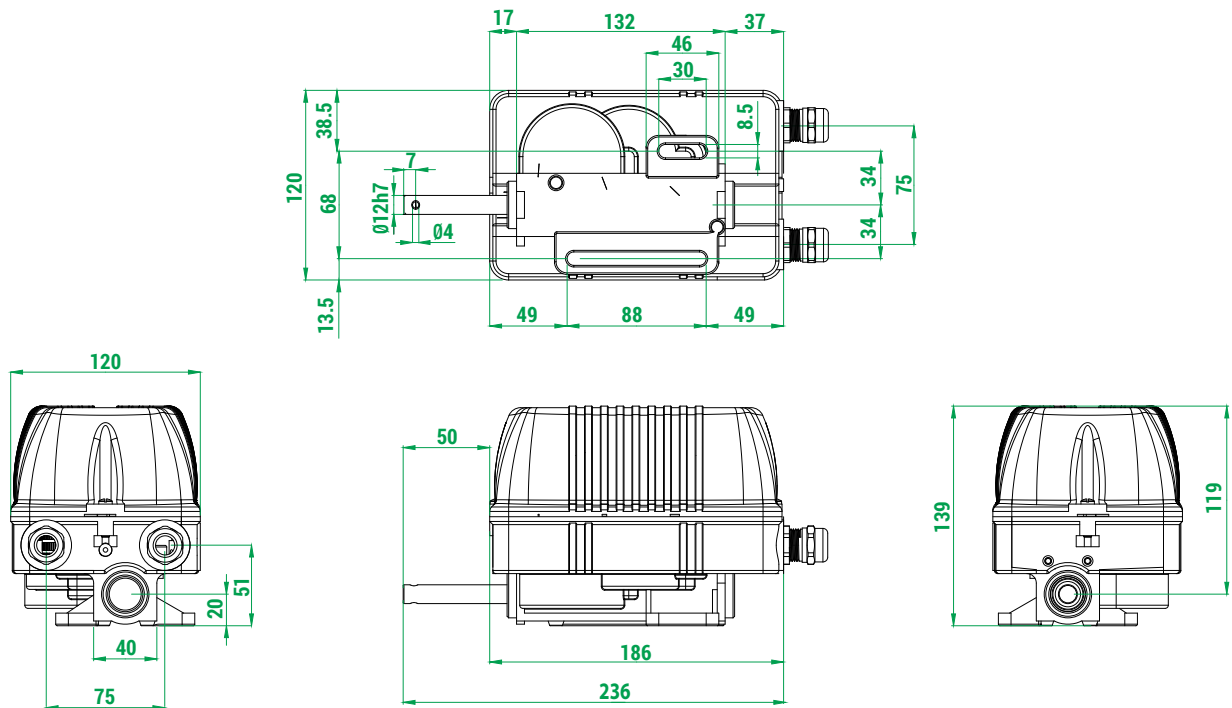

With flange

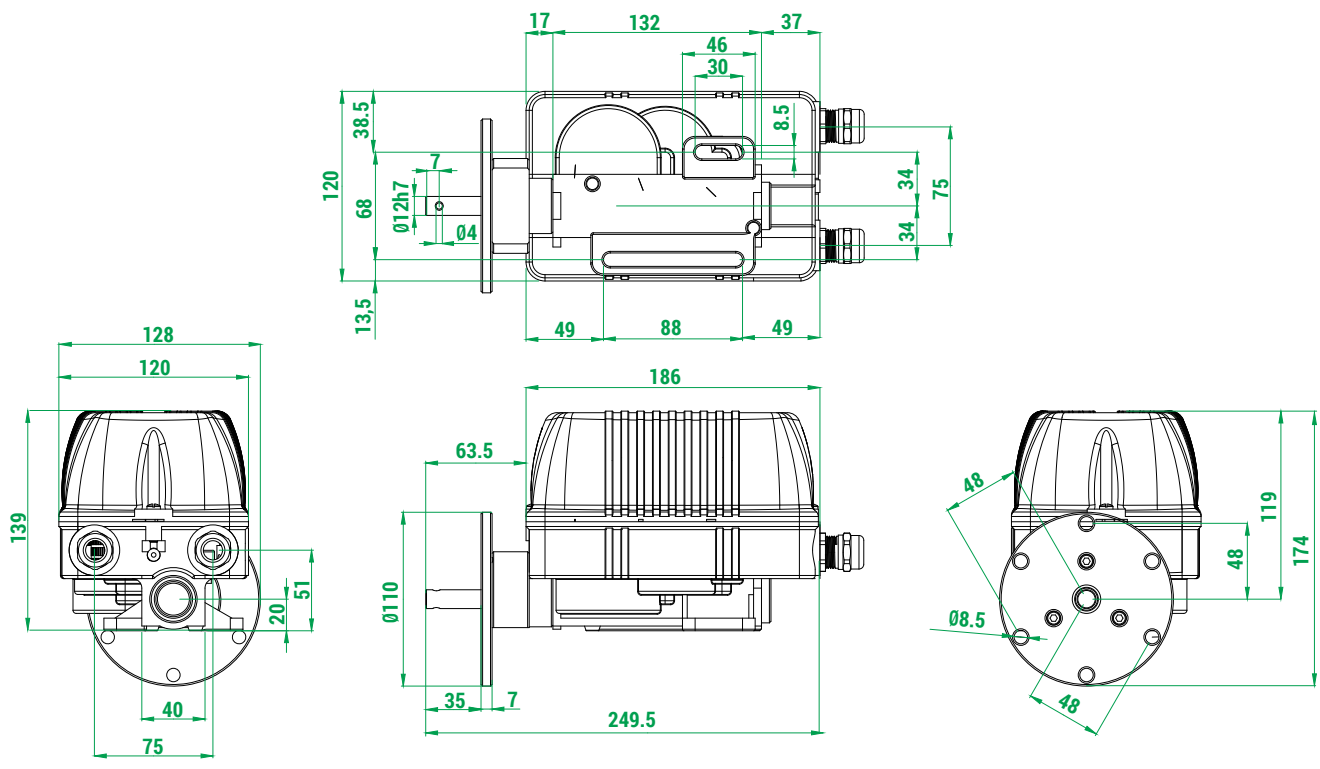

Top XL with cover rise

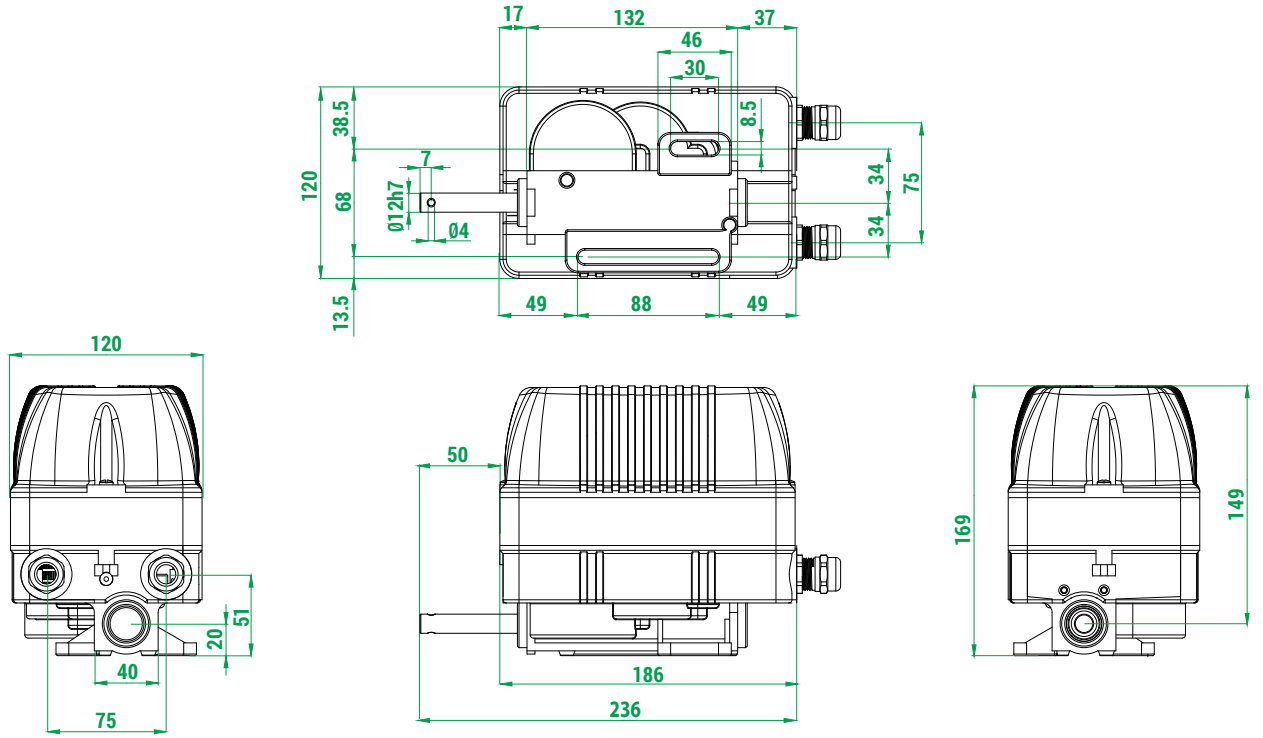

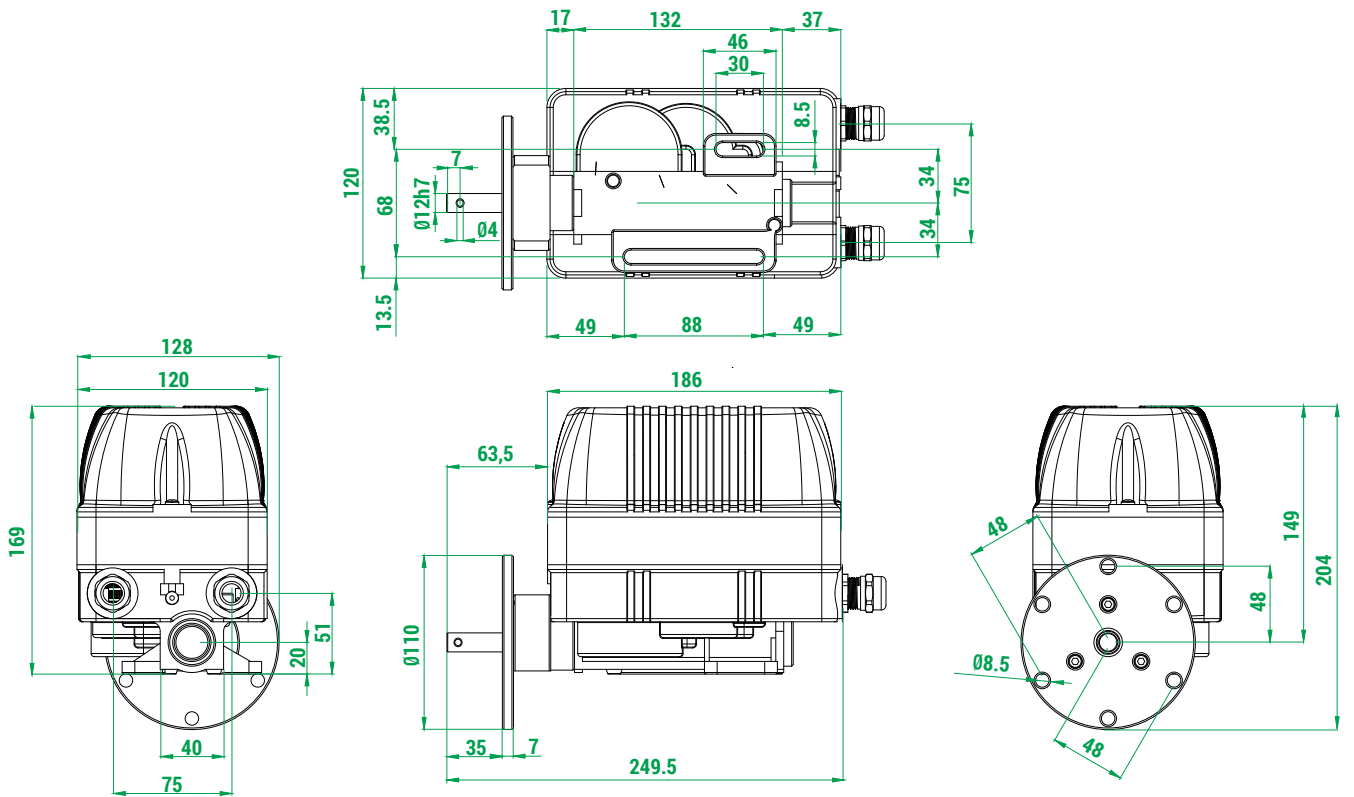

Top XL with cover rise and flange





STANDARD LIMIT SWITCHES

Standard limit switches are equipped with cams PRSL7194PI 

Standard limit switches are not cULus certified.

Rated revolution ratio	Real revolution ratio	No. of cams and switches	Switches	
			PRSL0110XX 1NO+1NC 	PRSL0111XX 1NC 
			Code	Code
1:1	1:1	2	PFD9067L0001002	PFD9067L0001008
		4	PFD9067L0001003	PFD9067L0001009
		4+2	PFD9067L0001004	PFD9067L0001010
		4+4	PFD9067L0001005	PFD9067L0001011
		4+4+2	PFD9067L0001006	PFD9067L0001012
		4+4+4	PFD9067L0001007	PFD9067L0001013
1:5	1:5	2	PFD9067L0005004	PFD9067L0005008
		4	PFD9067L0005005	PFD9067L0005009
		4+2	PFD9067L0005006	PFD9067L0005010
		4+4	PFD9067L0005002	PFD9067L0005011
		4+4+2	PFD9067L0005007	PFD9067L0005012
		4+4+4	PFD9067L0005003	PFD9067L0005013
1:10	1:10	2	PFD9067L0010008	PFD9067L0010012
		4	PFD9067L0010005	PFD9067L0010013
		4+2	PFD9067L0010004	PFD9067L0010014
		4+4	PFD9067L0010009	PFD9067L0010015
		4+4+2	PFD9067L0010010	PFD9067L0010016
		4+4+4	PFD9067L0010011	PFD9067L0010017
1:15	1:15.92	2	PFD9067L0015003	PFD9067L0015009
		4	PFD9067L0015004	PFD9067L0015010
		4+2	PFD9067L0015005	PFD9067L0015011
		4+4	PFD9067L0015006	PFD9067L0015012
		4+4+2	PFD9067L0015007	PFD9067L0015013
		4+4+4	PFD9067L0015008	PFD9067L0015014
1:20	1:20	2	PFD9067L0020006	PFD9067L0020009
		4	PFD9067L0020002	PFD9067L0020010
		4+2	PFD9067L0020003	PFD9067L0020011
		4+4	PFD9067L0020007	PFD9067L0020012
		4+4+2	PFD9067L0020004	PFD9067L0020013
		4+4+4	PFD9067L0020008	PFD9067L0020014
1:25	1:25	2	PFD9067L0025009	PFD9067L0025012
		4	PFD9067L0025004	PFD9067L0025013
		4+2	PFD9067L0025005	PFD9067L0025014
		4+4	PFD9067L0025010	PFD9067L0025015
		4+4+2	PFD9067L0025006	PFD9067L0025016
		4+4+4	PFD9067L0025011	PFD9067L0025017
1:50	1:50	2	PFD9067L0050009	PFD9067L0050013
		4	PFD9067L0050010	PFD9067L0050016
		4+2	PFD9067L0050011	PFD9067L0050017
		4+4	PFD9067L0050012	PFD9067L0050018
		4+4+2	PFD9067L0050014	PFD9067L0050019
		4+4+4	PFD9067L0050015	PFD9067L0050020

Rated revolution ratio	Real revolution ratio	No. of cams and switches	Switches	
			PRSL0110XX 1NO+1NC	PRSL0111XX 1NC
				
Code	Code			
1:75	1:75	2	PFD9067L0075002	PFD9067L0075009
		4	PFD9067L0075004	PFD9067L0075003
		4+2	PFD9067L0075005	PFD9067L0075010
		4+4	PFD9067L0075006	PFD9067L0075011
		4+4+2	PFD9067L0075007	PFD9067L0075012
		4+4+4	PFD9067L0075008	PFD9067L0075013
1:100	1:100	2	PFD9067L0100013	PFD9067L0100020
		4	PFD9067L0100015	PFD9067L0100021
		4+2	PFD9067L0100016	PFD9067L0100022
		4+4	PFD9067L0100017	PFD9067L0100023
		4+4+2	PFD9067L0100018	PFD9067L0100024
		4+4+4	PFD9067L0100019	PFD9067L0100025
1:150	1:150	2	PFD9067L0150007	PFD9067L0150012
		4	PFD9067L0150005	PFD9067L0150013
		4+2	PFD9067L0150008	PFD9067L0150014
		4+4	PFD9067L0150009	PFD9067L0150015
		4+4+2	PFD9067L0150010	PFD9067L0150016
		4+4+4	PFD9067L0150011	PFD9067L0150017
1:200	1:200	2	PFD9067L0200004	PFD9067L0200009
		4	PFD9067L0200005	PFD9067L0200010
		4+2	PFD9067L0200006	PFD9067L0200011
		4+4	PFD9067L0200002	PFD9067L0200012
		4+4+2	PFD9067L0200007	PFD9067L0200013
		4+4+4	PFD9067L0200008	PFD9067L0200014
1:250	1:250	2	PFD9067L0250012	PFD9067L0250016
		4	PFD9067L0250013	PFD9067L0250010
		4+2	PFD9067L0250009	PFD9067L0250017
		4+4	PFD9067L0250001	PFD9067L0250028
		4+4+2	PFD9067L0250014	PFD9067L0250019
		4+4+4	PFD9067L0250015	PFD9067L0250011
1:300	1:300	2	PFD9067L0300004	PFD9067L0300010
		4	PFD9067L0300005	PFD9067L0300011
		4+2	PFD9067L0300006	PFD9067L0300012
		4+4	PFD9067L0300007	PFD9067L0300013
		4+4+2	PFD9067L0300008	PFD9067L0300014
		4+4+4	PFD9067L0300009	PFD9067L0300015
1:450	1:450	2	PFD9067L0450001	PFD9067L0450008
		4	PFD9067L0450003	PFD9067L0450002
		4+2	PFD9067L0450004	PFD9067L0450009
		4+4	PFD9067L0450005	PFD9067L0450010
		4+4+2	PFD9067L0450006	PFD9067L0450011
		4+4+4	PFD9067L0450007	PFD9067L0450012

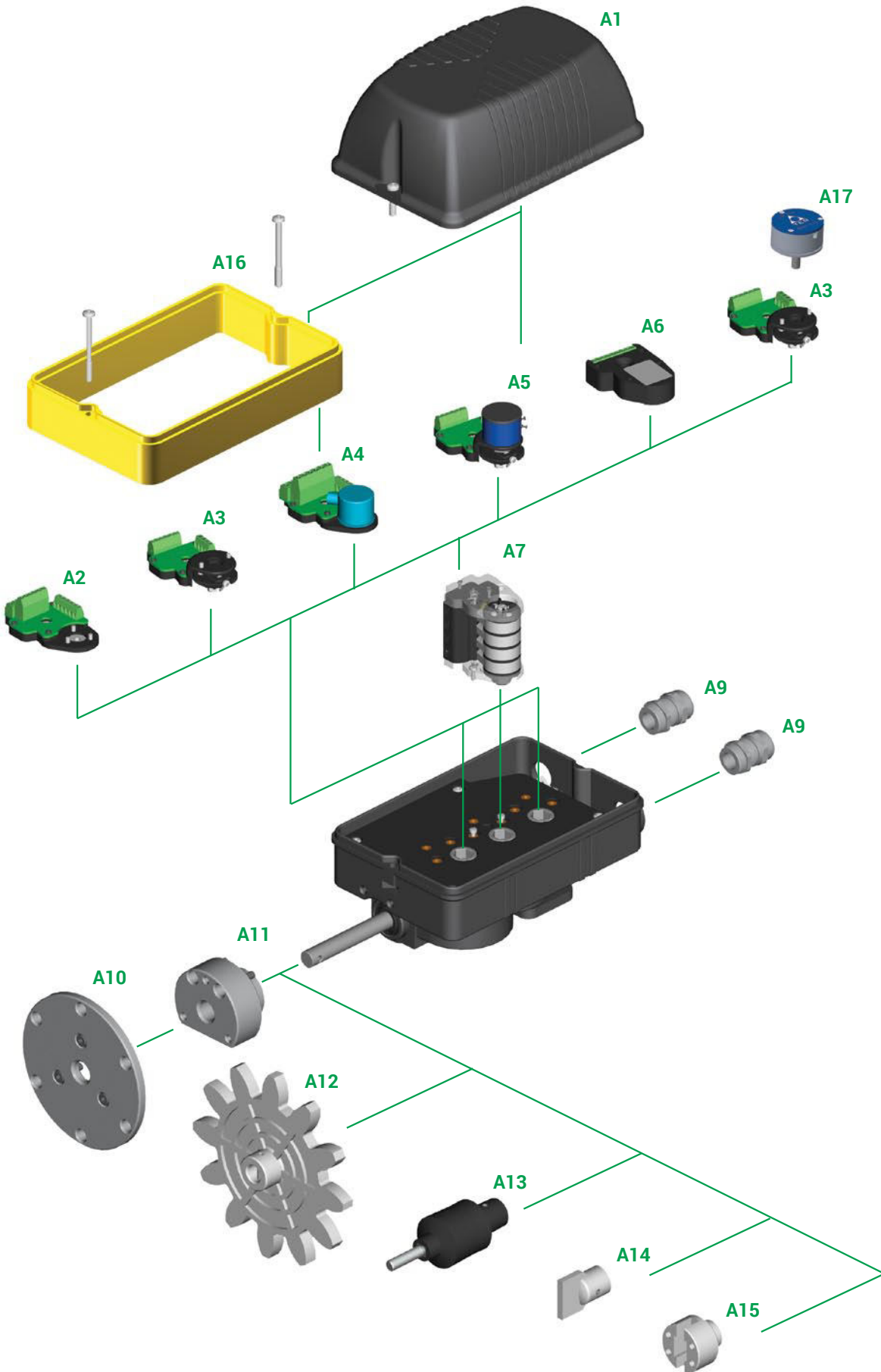



Refer to the following tables for descriptions of components: "Standard cam sets", "Potentiometers and encoders" and "Accessories".

COMPONENTS







Standard cam sets

4







Ref.	Drawing	No. and type of cams	No. and type of switches	Code	
A7		2 cams A	2 PRSL0110XX switches	FCL20001	
		2 cams A	2 PRSL0111XX switches	FCL20002	
		Cams A+C	2 PRSL0110XX switches	FCL20003	
		Cams A+C	2 PRSL0111XX switches	FCL20004	
		2 cams C	2 PRSL0110XX switches	FCL20005	
		2 cams C	2 PRSL0111XX switches	FCL20006	
			Cams D+D+B+F	4 PRSL0110XX switches	FCL40001
			Cams D+D+B+F	4 PRSL0111XX switches	FCL40002
			4 cams A	4 PRSL0110XX switches	FCL40003
			4 cams A	4 PRSL0111XX switches	FCL40004
			Cams A+A+C+C	4 PRSL0110XX switches	FCL40005
			Cams A+A+C+C	4 PRSL0111XX switches	FCL40006
			4 cams C	4 PRSL0110XX switches	FCL40007
			4 cams C	4 PRSL0111XX switches	FCL40008
			Cams C+C+C+E	4 PRSL0110XX switches	FCL40009
			Cams C+C+C+E	4 PRSL0111XX switches	FCL40010
			Cams A+A+E+E	4 PRSL0110XX switches	FCL40011
			Cams A+A+E+E	4 PRSL0111XX switches	FCL40012

Other sets with 2/3/4/5 or 6 cams/switches are available on request.





Cam reference chart

Cam			Code for PRSL0110XX switches	Switching angle with PRSL0110XX	Code for PRSL0111XX switches	Switching angle with PRSL0111XX
A		1 point	PRSL7194PI	21.5° ±0.5°	PRSL7194PI	23.0° ±0.5°
B		10 points	PRSL7193PI	21.5° ±0.5°	PRSL7193PI	23.0° ±0.5°
C		60° sector	PRSL7195PI	82.0° ±0.5°	PRSL7195PI	86.0° ±0.5°
D		72° sector	PRSL7196PI	94.0° ±0.5°	PRSL7196PI	97.5° ±0.5°
E		180° sector	PRSL7191PI	204.5° ±0.5°	PRSL7191PI	203.0° ±0.5°
F		305° sector	PRSL7192PI	328.5° ±0.5°	PRSL7192PI	327.0° ±0.5°

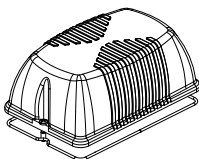

Potentiometers and encoders

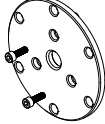
Ref.	Drawing	Description	Code
A2		Support for encoder	PA030000
A3		Support for potentiometer	PA020000
A4		Encoder 36 pulses./rev. with support	PA030001
		Encoder 150 pulses./rev. with support	PA030002
A5		Potentiometer 10 kΩ with support	PA020001
		Potentiometer 10 kΩ mechanical stop with support	PA020002
		Potentiometer 10 kΩ ±10% 4 pins with support	PA020003
		Potentiometer 10 kΩ ±10% 3 pins with support	PA020004
		Potentiometer 5 kΩ ±10% with support	PA020005
		Potentiometer 4.7 kΩ with support	PA020006
		Potentiometer 10 kΩ with support	PA020007
		Potentiometer 2.2 kΩ with support	PA020008
A6		Absolute encoder Yankee - current output	PA01AA01
		Absolute encoder Yankee - voltage output	PA01AB01
		Absolute encoder Yankee - PWM output	PA01AC01
A17		Absolute encoder Egon 36-AL	F19XXXXXXXXX (Use the form on page 19 to generate codes)

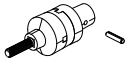
Accessories

Ref.	Drawing	Description	Code
A1		Cover with gasket, screws and earth cable	PA090018
A9		Cable clamp M20x1.5	PRPS1075PE
A10		Flange with screws	PRTR1300PE
A11		Flange support	PRT03018PE
A12		Pinion gear	See pinion gear tables
A13		Coupling with pin	PRSL0981PI

Accessories

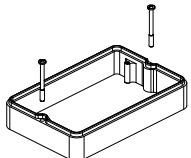
Ref.	Drawing	Description	Code
A14		Male coupling with pin	PRSL0919PI
A15		Female coupling with pin	PRSL0920PI
A16		Cover rise with gasket, screws and earth cable	PRSL0707PI

Moulded pinion gears

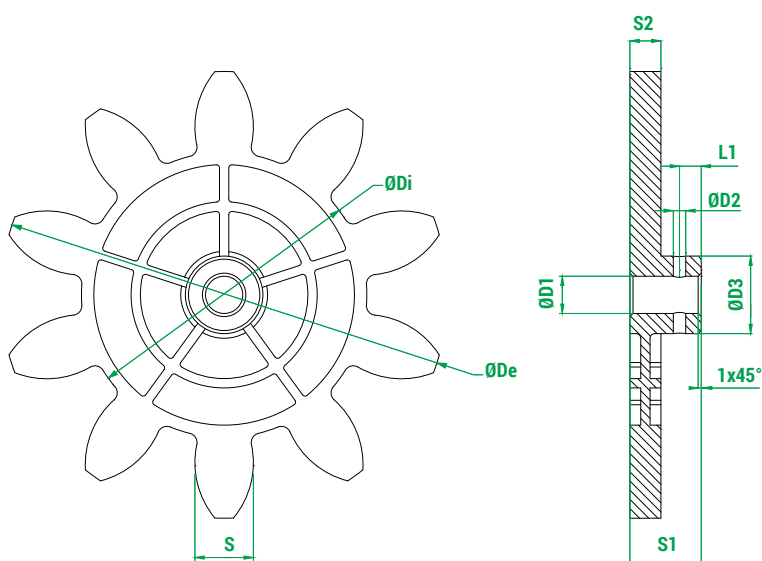

Legend

Z	Number of teeth
M	Module
Dp	Primitive diameter
De	External diameter
Di	Internal diameter
a	Addendum
d	Dedendum
Alpha	Pressure angle

Code	Z	M	Dp	De	Di	a	d	S	Alpha	D1	D2	D3	S1	S2	L1
PRSL0915PI	8	20.00	160.00	200.00	113.20	20.00	23.40	31.41	20.00	12.00	4.00	24.00	23.00	10.00	7.00
PRSL0912PI	10	12.00	120.00	144.00	92.00	12.00	14.00	18.85	20.00	12.00	4.00	25.00	23.00	10.00	7.00
PRSL0913PI	10	14.00	140.00	168.00	107.24	14.00	16.38	21.99	20.00	12.00	4.00	24.60	23.00	10.00	7.00
PRSL0914PI	10	16.00	160.00	192.00	122.67	16.00	18.67	25.13	20.00	12.00	4.00	24.00	23.00	10.00	7.00
PRSL0917PI	11	6.00	66.00	78.00	51.96	6.00	7.02	9.42	20.00	12.00	4.00	19.00	23.00	8.00	7.00
PRSL0916PI	12	5.00	60.00	70.00	48.30	5.00	5.83	7.85	20.00	12.00	4.00	20.00	23.00	8.00	7.00
PRSL0918PI	12	8.00	96.00	112.00	77.28	8.00	9.36	12.56	20.00	12.00	4.00	21.50	23.50	10.00	7.00
PRSL0911PI	12	10.00	120.00	140.00	96.67	10.00	11.67	15.71	20.00	12.00	4.00	25.00	23.50	10.00	7.00
PRSL0944PI	12	12.00	144.00	168.00	116.00	12.00	14.00	18.85	20.00	12.00	4.00	24.00	23.00	10.00	7.00

Measuring unit: mm.

Waterjet cut pinion gears

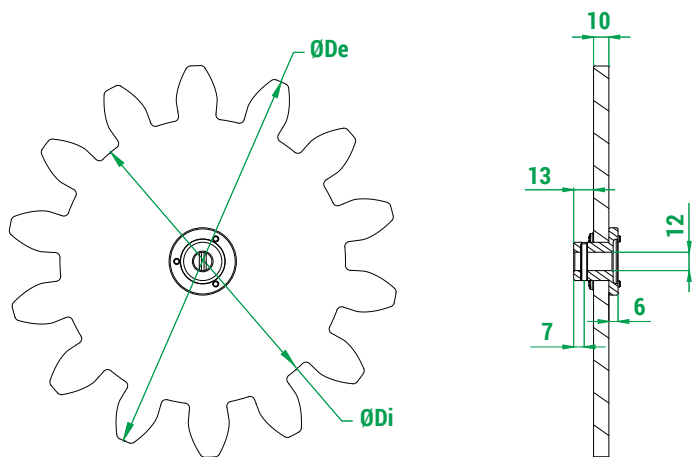

Legend

Z	Number of teeth
M	Module
Dp	Primitive diameter
De	External diameter
Di	Internal diameter
a	Addendum
d	Dedendum
Alpha	Pressure angle

Code	Z	M	Dp	De	Di	a	d	Alpha
PRSL0857PI	8	18.00	144.00	180.00	102.00	18.00	21.00	20.00
PRSL0855PI	8	24.00	192.00	240.00	136.00	24.00	28.00	20.00
PRSL0992PI	9	10.00	90.00	110.00	66.67	10.00	11.67	20.00
PRSL0879PI	9	16.00	144.00	176.00	106.67	16.00	18.67	20.00
PRSL0854PI	9	18.00	162.00	198.00	120.00	18.00	21.00	20.00
PRSL0871PI	9	20.00	180.00	220.00	133.33	20.00	23.33	20.00
PRSL0849PI	9	24.00	216.00	264.00	160.00	24.00	28.00	20.00
PRSL0846PI	10	10.00	100.00	120.00	76.67	10.00	11.67	20.00
PRSL0993PI	10	18.00	180.00	216.00	138.00	18.00	21.00	20.00
PRSL0970PI	10	22.00	220.00	264.00	168.52	22.00	25.74	20.00
PRSL0856PI	10	24.00	240.00	288.00	184.00	24.00	28.00	20.00
PRSL0861PI	11	12.00	132.00	156.00	104.00	12.00	14.00	20.00
PRSL0998PI	11	18.00	198.00	234.00	156.00	18.00	21.00	20.00
PRSL0997PI	11	20.00	220.00	260.00	173.36	20.00	23.32	20.00
PRSL0859PI	11	24.00	264.00	312.00	204.00	24.00	30.00	20.00
PRSL0863PI	12	14.00	168.00	196.00	133.00	14.00	17.50	20.00
PRSL0897PI	12	16.00	192.00	224.00	154.67	16.00	18.67	20.00
PRSL0972PI	12	18.00	216.00	252.00	173.88	18.00	21.06	20.00
PRSL0845PI	12	20.00	240.00	280.00	193.34	20.00	23.32	20.00
PRSL0878PI	12	24.00	288.00	336.00	232.00	24.00	28.00	20.00
PRSL0860PI	13	6.00	78.00	90.00	63.00	6.00	7.50	20.00
PRSL0853PI	13	12.00	156.00	178.59	126.00	11.29	15.00	20.00
PRSL0898PI	13	16.00	208.00	240.00	170.67	16.00	18.66	20.00
PRSL0862PI	14	10.00	140.00	169.00	125.00	15.00	7.50	20.00
PRSL0896PI	14	16.00	224.00	256.00	186.67	16.00	18.67	20.00
PRSL0999PI	14	18.00	252.00	288.00	210.00	18.00	21.00	20.00
PRSL0848PI	14	20.00	280.00	320.00	233.33	20.00	23.33	20.00
PRSL0858PI	15	18.00	270.00	306.00	228.00	18.00	21.00	20.00
PRSL0847PI	16	20.00	320.00	360.00	273.33	20.00	23.33	20.00
PRSL0973PI	17	10.00	170.00	190.00	145.00	10.00	12.50	22.89
PRSL0974PI	17	14.00	238.00	266.00	203.00	14.00	17.50	22.89
PRSL0851PI	20	6.00	120.00	132.00	105.00	6.00	7.50	22.89
PRSL0844PI	25	1.00	25.00	27.00	22.50	1.00	1.25	22.89

Unità di misura: mm.

TOP - REQUEST FORM FOR NON STANDARD LIMIT SWITCH

Instructions

(See next pages for list of components and legends)

- 1 Version:** tick the required version.
- 2 SIL 1 certified:** tick the box if you require SIL 1 certified units.
- 3 Revolution ratio:** write the required revolution ratio for each output.
- 4 Standard cam sets:** write the code of the cam set required for each output.
- 5 Customized cam sets:** for non standard cam sets, fill in the scheme choosing the cams and the switches required. It is possible to assemble sets with 2, 3, 4, 5 or 6 cams/switches. Customized cams are available on request.
- 6 Potentiometers, encoders, Egon 36-AL, Yankee:** write the code of the potentiometer, encoder, Egon 36-AL or Yankee required.
 ATTENTION: potentiometer PA020009 can be mounted only alone, i.e. with NO sets of cams.
 Please refer to the table on the next pages for all other possible configurations.
 To generate Egon 36-AL codes, use the form on the following pages.
- 7 Shaft:** tick the shaft type required.
 Customized shafts are available on request.
- 8 Coupling, flange, pinion gear:** tick the box when coupling, flange or pinion gear are required.
 When a standard pinion gear is required, write the code number listed in the pinion gear tables in the catalogue.
 When a special pinion gear is required, write the number of teeth, the module and the primitive diameter.

Version 1

- Version **CE EAC**
- Version **cULus CE EAC**
- Version with anti-moisture plug **CE EAC**

ATTENTION: Top XL with cover rise are not cULus certified.

For ambient temperature -40° C / +100°C

SIL 1 certified 2

ATTENTION: Top XL with cover rise are not SIL1 certified.

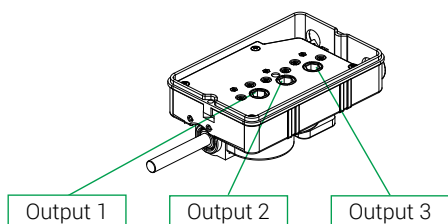

Revolution ratio 3

Output 1			Output 2			Output 3		
1	2	3	1	2	3	1	2	3
<input type="checkbox"/>	<input type="checkbox"/>	<input type="checkbox"/>	<input type="checkbox"/>	<input type="checkbox"/>	<input type="checkbox"/>	<input type="checkbox"/>	<input type="checkbox"/>	<input type="checkbox"/>
		1:1			1:50			1:300
<input type="checkbox"/>	<input type="checkbox"/>	<input type="checkbox"/>	<input type="checkbox"/>	<input type="checkbox"/>	<input type="checkbox"/>	<input type="checkbox"/>	<input type="checkbox"/>	<input type="checkbox"/>
		1:5			1:75			1:450
<input type="checkbox"/>	<input type="checkbox"/>	<input type="checkbox"/>	<input type="checkbox"/>	<input type="checkbox"/>	<input type="checkbox"/>	<input type="checkbox"/>	<input type="checkbox"/>	<input type="checkbox"/>
		1:10			1:100			1: _____
<input type="checkbox"/>	<input type="checkbox"/>	<input type="checkbox"/>	<input type="checkbox"/>	<input type="checkbox"/>	<input type="checkbox"/>	<input type="checkbox"/>	<input type="checkbox"/>	<input type="checkbox"/>
		1:15			1:150			1: _____
<input type="checkbox"/>	<input type="checkbox"/>	<input type="checkbox"/>	<input type="checkbox"/>	<input type="checkbox"/>	<input type="checkbox"/>	<input type="checkbox"/>	<input type="checkbox"/>	<input type="checkbox"/>
		1:20			1:200			1: _____
<input type="checkbox"/>	<input type="checkbox"/>	<input type="checkbox"/>	<input type="checkbox"/>	<input type="checkbox"/>	<input type="checkbox"/>	<input type="checkbox"/>	<input type="checkbox"/>	<input type="checkbox"/>
		1:25			1:250			

Standard cam sets 4

Cam set code _____	Output 1
_____	Output 2
_____	Output 3

Customized cam sets 5

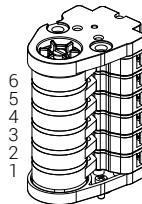

Output 1	Cam code	Switch code
6	_____	_____
5	_____	_____
4	_____	_____
3	_____	_____
2	_____	_____
1	_____	_____
Output 2	Cam code	Switch code
6	_____	_____
5	_____	_____
4	_____	_____
3	_____	_____
2	_____	_____
1	_____	_____
Output 3	Cam code	Switch code
6	_____	_____
5	_____	_____
4	_____	_____
3	_____	_____
2	_____	_____
1	_____	_____

Potentiometers, encoders, Egon 36-AL, Yankee 6

	Output 1	Output 2	Output 3
Code	_____	_____	_____

Standard shaft 7

Flexible shaft

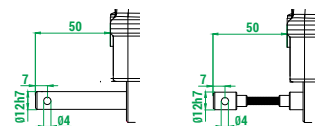

Male coupling

Coupling 8

Female coupling

Flange

Pinion gear

Pinion gear code _____

Customized pinion gear

No. of teeth _____

Module _____

Primitive diameter _____



4 Legend - Standard cam sets

No. & type of switches	No. & type of cams	Code
2 x PRSL0110XX	2 cams A	FCL20001
	Cams A+C	FCL20003
4 x PRSL0110XX	2 cams C	FCL20005
	Cams D+D+B+F	FCL40001
	4 cams A	FCL40003
	Cams A+A+C+C	FCL40005
	4 cams C	FCL40007
	Cams C+C+C+E	FCL40009
2 x PRSL0111XX	Cams A+A+E+E	FCL40011
	2 cams A	FCL20002
	Cams A+C	FCL20004
4 x PRSL0111XX	2 cams C	FCL20006
	Cams D+D+B+F	FCL40002
	4 cams A	FCL40004
	Cams A+A+C+C	FCL40006
	4 cams C	FCL40008
	Cams C+C+C+E	FCL40010
	Cams A+A+E+E	FCL40012







6 Legend - Potentiometers, encoders and Yankee

Description	Code
Potentiometer 10 kΩ with support	PA020001
Potentiometer 10 kΩ mechanical stop with support	PA020002
Potentiometer 10 kΩ ±10% 4 pins with support	PA020003
Potentiometer 10 kΩ ±10% 3 pins with support	PA020004
Potentiometer 5 kΩ ±10% with support	PA020005
Potentiometer 4.7 kΩ with support	PA020006
Potentiometer 10 kΩ with support	PA020007
Potentiometer 2.2 kΩ with support	PA020008
Potentiometer 2KΩ with support	PA020009
Encoder 36 pulses./rev. with support	PA030001
Encoder 150 pulses./rev. with support	PA030002
Yankee - current output	PA01AA01
Yankee - voltage output	PA01AB01
Yankee - PWM output	PA01AC01

5 Legend - Switches

PRSL0110XX	PRSL0111XX
1NO+1NC	1NC
	

5 Legend - Standard cams

Cam			Code for PRSL0110XX switches	Switching angle with PRSL0110XX	Code for PRSL0111XX switches	Switching angle with PRSL0111XX
A		1 point	PRSL7194PI	21.5° ±0.5°	PRSL7194PI	23.0° ±0.5°
B		10 points	PRSL7193PI	21.5° ±0.5°	PRSL7193PI	23.0° ±0.5°
C		60° sector	PRSL7195PI	82.0° ±0.5°	PRSL7195PI	86.0° ±0.5°
D		72° sector	PRSL7196PI	94.0° ±0.5°	PRSL7196PI	97.5° ±0.5°
E		180° sector	PRSL7191PI	204.5° ±0.5°	PRSL7191PI	203.0° ±0.5°
F		305° sector	PRSL7192PI	328.5° ±0.5°	PRSL7192PI	327.0° ±0.5°

6 Configuration table

The following table shows possible configurations of Top and Top XL.

When it is not possible to mount a set of cams together with a potentiometer/encoder, the table shows «Not available.»

When the standard cover PA090018 is not high enough to hold the elements mounted inside the limit switch, it is possible to use the cover rise PRSL0707PI (the table shows «Top XL»).

In all other cases it is possible to mount the sets of cams and potentiometer/encoder with the standard cover PA090018 (the table shows «Top»).

	Set of cams with 2 switches	Set of cams with 3 switches	Set of cams with 4 switches	Set of cams with 5 switches	Set of cams with 6 switches
Set of cams only	Top	Top	Top	Top	Top XL
Set of cams + Egon 36-AL	Top	Top XL	Top XL	Not available	Not available
Set of cams + Yankee1	Top	Top	Top	Top XL	Top XL
Set of cams + PA020001	Top	Top XL	Top XL	Not available	Not available
Set of cams + PA020002	Top	Top XL	Top XL	Not available	Not available
Set of cams + PA020003	Top	Top XL	Top XL	Top XL	Not available
Set of cams + PA020004	Top	Top XL	Top XL	Top XL	Not available
Set of cams + PA020005	Top	Top XL	Top XL	Top XL	Not available
Set of cams + PA020006	Top	Top XL	Top XL	Not available	Not available
Set of cams + PA020007	Top	Top XL	Top XL	Not available	Not available
Set of cams + PA020008	Top	Top XL	Top XL	Not available	Not available
Set of cams + PA030001	Top	Top XL	Top XL	Top XL	Not available
Set of cams + PA030002	Top	Top XL	Top XL	Top XL	Not available

6 Configuration form for Egon 36-AL

To generate the encoder code, fill in the boxes with the characters corresponding to the specifications required, as shown in the example. Enter the code in the space provided at point 6 (Potentiometers, encoders, Egon 36-AL, Yankee) of the «Request form for non standard limit switch».

F19 R A 1 1 0 X X X

F19		A			0	X	X	X
-----	--	---	--	--	---	---	---	---

S = normal
R = redundant

A = analog

Output 1
1 = 4...20 mA
2 = 1...5 V
3 = 2...10 V

Output 2
 (only for EGON 36-AL redundant version)*
1 = 4...20 mA
2 = 1...5 V
3 = 2...10 V

* Fill in "0" for Egon36-AL normal version.
 ATTENTION: if required, Output 2 must be the same as Output 1.

Characters for sequential numbers

