

FOX

Rotary limit switch



Rotary limit switch used to control and measure the movement of industrial machines by reading the rotation angle and/or counting the number of revolutions of a shaft.
Fox is used on wind turbines to control the position of the nacelle or the pitch angle of the blades.

FEATURES

- It consists of a gear motor that transfers movement to the cams and the other movement detection devices through a primary input reduction stage (worm gear and helical toothed gear) and one or more secondary output stages (pairs of straight toothed gears).
- Accurate adjustment of cams by means of screws.
- Positive opening NC contacts for safety functions.
- Mechanical life of switches: up to 10 million operations.
- IP protection degree: Fox is classified IP66, IP67 and IP69K.
- NEMA protection degree: Fox is classified Type 4X*.
- Extreme temperature resistance: -40°C to +80°C.
- It features transmission and gear driving shafts made of stainless steel AISI 430F or AISI 303. worm gear transmission shaft rotating on ball bearings, self-lubricating technopolymer gears and driving bushes, technopolymer base and cover.
- All materials and components used are wear resistant and guarantee protection of the unit against water and dust.

OPTIONS

- Revolution ratios from 1:3 to 1:2870, achieved by combining different secondary output stages.
- Snap action switches with 1NO+1NC contacts or slow action switches with 1NC contact.
- It can be equipped with a cam set (with up to 5 switches) and potentiometers, encoders, Yankee absolute encoders.
- Dedicated cable clamps or connectors.
- Available with anti-moisture plug fitted to the base by means of a lock nut, to improve transpiration for the limit switch while maintaining protection against water.
- Available with flanges, pinion gears and couplings.
- Plates with universal adapter to replace existing systems.

CERTIFICATIONS

- CE marking, cULus* marking and EAC certification.
- Fox is available, upon request, with the SIL1 certification (Safety Integrity Level 1), according to Standard IEC 61508.
- Complying with accident prevention regulation BGV C 1 (only for Germany).
- HALT TEST (Highly Accelerated Life Test) passed, simulating conditions largely exceeding standard operating conditions.

UK Distributor



Tel: 0115 932 7010 | Email: sales@metreel.co.uk
www.metreel.co.uk

* Not available on all versions.

The data and the products illustrated in this brochure may be modified without notice. Under no circumstances can their description have a contractual value.

POSSIBLE ASSEMBLIES

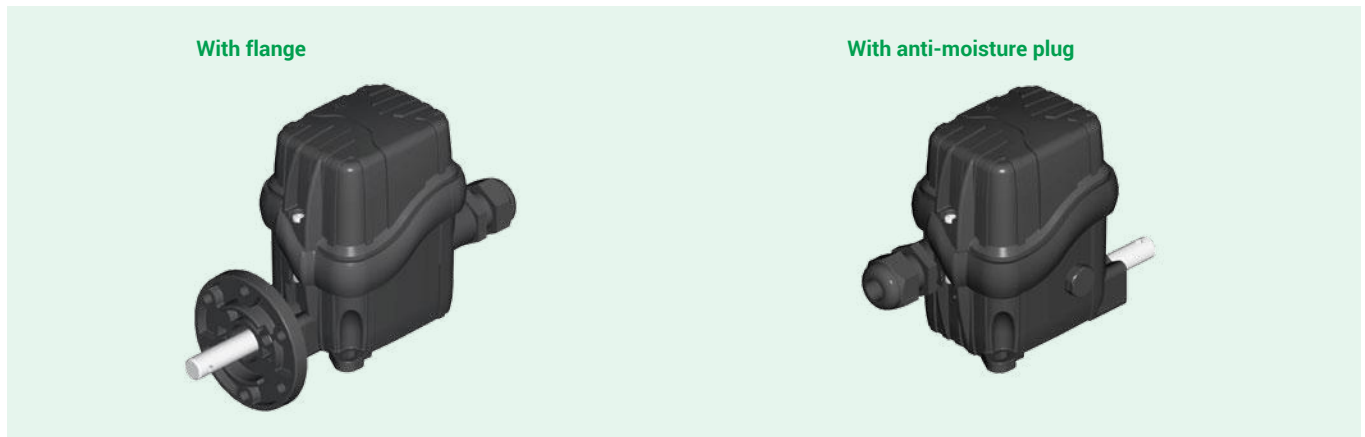

CERTIFICATIONS







Conformity to Community Directives	2014/35/UE Low Voltage Directive
	2006/42/CE Machinery Directive
	EN 60204-1 Safety of machinery - Electrical equipment of machines
Conformity to CE Standards	EN 60204-32 Safety of machinery - Electrical equipment of machines - Requirements for hoisting machines
	EN 60947-1 Low-voltage switchgear and controlgear
	EN 60947-5-1 Low-voltage switchgear and controlgear - Control circuit devices and switching elements - Electromechanical control circuit devices
	EN 60529 Degrees of protection provided by enclosures
Conformity to cULus Standards	CSA-C22.2 No 14-13 Industrial Control Equipment
	UL 508 Industrial Control Equipment
SIL1	IEC 61508:2010 Part 2-4-6-7 Functional safety of electrical / electronic / programmable electronic safety-related systems
BGV C 1	Regulations for the prevention of accidents BGV C 1 (only for Germany)
HALT TEST	Highly Accelerated Life Test, simulation of conditions largely exceeding the standard operating conditions (data available on request)
Markings and homologations	CE cULus* EAC

GENERAL TECHNICAL SPECIFICATIONS

Ambient temperature	Storage -40°C/+80°C
	Operational -40°C/+80°C
IP protection degree	IP 66/IP 67/IP 69K
NEMA protection degree	Type 4X*
Insulation category	Class II
Maximum rotation speed	Revolution ratios $\geq 1:16$: max. 800 rpm
	Revolution ratios $< 1:16$: max. 200 rpm
	Revolution ratios =1:50 and 1:100: max. 1500 rpm
Cable entry	Cable clamp M20
	Cable clamp M20+M16
	Cable clamp M20+M20
Shafts	Stainless steel AISI 430F (version not cULus)
	Stainless steel AISI 303

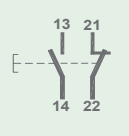
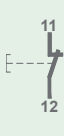
* Not available on all versions.

TECHNICAL SPECIFICATIONS OF THE SWITCHES

Code	PRSL0110XX	PRSL0111XX
Utilisation category	AC 15	
Rated operational voltage	250 Vac	
Rated operational current	3 A	
Rated thermal current	10 A	
Rated insulation voltage	300 Vac	
Mechanical life	10x10 ⁶ operations	
Connections	Screw-type terminals	
Wires	1x2.5 mm ² , 2x1.5 mm ² (UL (c)UL: use 60°C or 75°C copper (CU) conductors and stiff or flexible wire 14-22 AWG)	
Tightening torque	0.5 Nm	
Microswitch type	Double break. snap action	Double break. slow action
Contacts	1NO+1NC (All NC contacts are of the positive opening operation type )	1NC (All NC contacts are of the positive opening operation type )
Scheme		
Markings and homologations	  	

Switches PRSL0100XX available on request.

TECHNICAL SPECIFICATIONS OF THE POTENTIOMETERS

Code of potentiometer with support	PA020001	PA020002
Ohmic value	10 kΩ	10 kΩ mechanical stop
Resolution	Infinite	
Independent linearity	±1%	
Life time	10x10 ⁶ movements	
Operational ambient temperature	-55°C/+105°C	
Continuos rotation (without stop)	360°	
Continuos rotation (with stop)	333° ±5°	
Actual electrical angle	310° ±5°	
Ohmic value tolerance	±20%	

Code of potentiometer with support	PA020003	PA020004	PA020005
Ohmic value	10 kΩ	10 kΩ	5 kΩ
Connections	4 turrets	3 turrets	4 turrets
Independent linearity (over AEA -3°)	≤±1%	≤±0.35%	≤±1%
Life time	5x10 ⁶ movements		
Operational ambient temperature	-55°C/+125°C		
Mechanical angle	360° continuous		
Actual Electrical Angle (AEA)	340°±5°		
Ohmic value tolerance	Max ±20% at 20°C	Max ±10% at 20°C	Max ±20% at 20°C

TECHNICAL SPECIFICATIONS OF THE ENCODERS

Code with support	PA030001	PA030002
Resolution	36 pulses/rev.	150 pulses/rev.
Operational ambient temperature	-40°C/+85°C	
Code	Incremental	
Supply voltage	4.5 Vdc min. to 30 Vdc max. (35 mA max. - no load)	
Output voltage	Low: 500 mV max. at 10 mA High: (Vin - 0.6) at -10 mA (Vin - 1.3) at -25 mA	
Output current	25 mA max. load per output channel	
Output format	Two channel (A, B) quadrature with Index (Z)	
Phase sense	A leads B clockwise (CW) from the mounting end of the encoder	
Accuracy	+/- 0.8 arc-min.	
Outputs	Push pull	
Electrical protection	Protection against reverse polarity and output short-circuit	

CERTIFICATIONS OF THE ABSOLUTE ENCODER YANKEE

Conformity to Community Directives	2014/30/UE Electromagnetic Compatibility (EMC) Directive
	2006/42/CE Machinery Directive
	2014/35/UE Low Voltage Directive (LVD)
Conformity to CE Standards	EN 61326-1 Electrical equipment for measurement, control and laboratory use - EMC requirements
	EN 60529 Degrees of protection provided by enclosures
Conformity to cULus Standards	CSA-C22.2 No 14-13 Industrial Control Equipment
	UL 508 Industrial Control Equipment
Markings and homologations	CE 

GENERAL TECHNICAL SPECIFICATIONS OF THE ABSOLUTE ENCODER YANKEE

Ambient temperature	Storage -40°C/+80°C
	Operational -40°C/+80°C
IP protection degree	IP 20
Free rotation	360°
Maximum rotation speed	800 rpm

ELECTRICAL SPECIFICATIONS OF THE ABSOLUTE ENCODER YANKEE

Code	PA01AA01	PA01AB01	PA01AC01
Analog output	Current 4 ÷ 20 mA	Voltage 0 ÷ 10 V	PWM 0 ÷ 100 %
Power supply	12 ÷ 48 Vdc/12 ÷ 48 Vac		
Protection against reverse polarity	Yes		
Absorption	50 mA		
Resolution	10 bit		
Linearity	+/- 0.5°		
Max. hysteresis	0.1°		
Zero Point setting	Through button/wire		
Signal increment direction	CW (standard)/CCW (on request)		
Connections	Terminal board		
Terminal wires	0.14 mm ² - 1.5 mm ²		
Terminal tightening torque	0.22 Nm - 0.25 Nm		

OVERALL DIMENSIONS (mm)

Standard

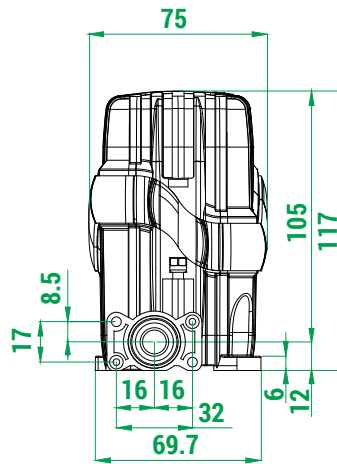
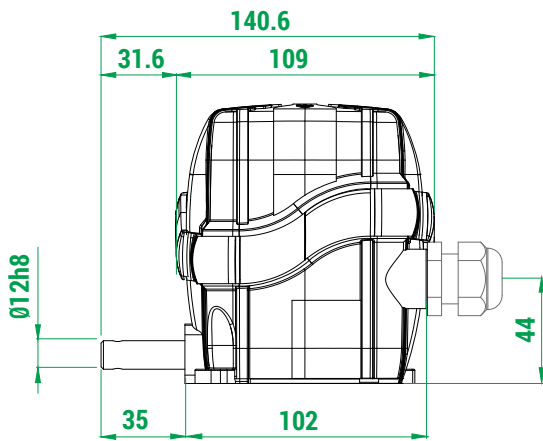
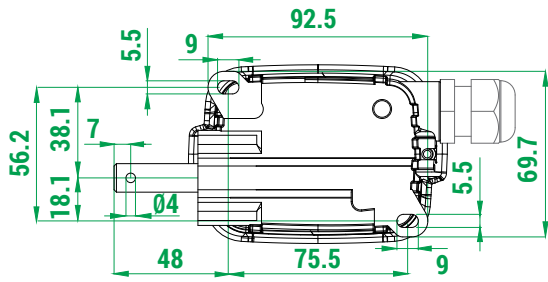

With flange

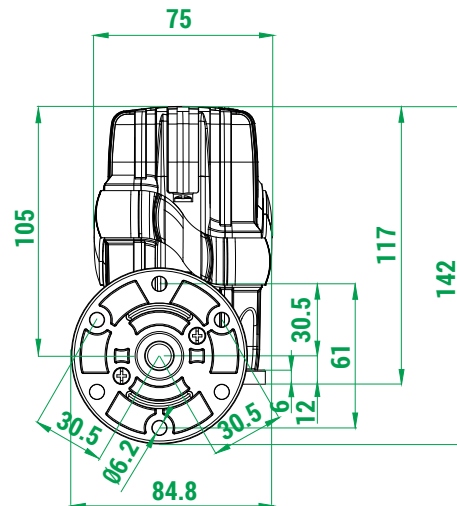
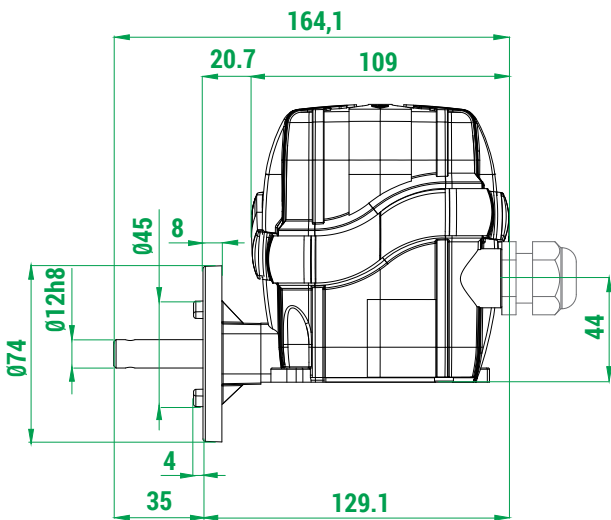
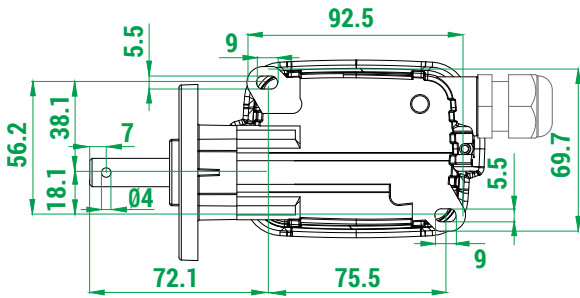

STANDARD LIMIT SWITCHES

Standard limit switches are equipped with cams PRSL7194PI  and shafts made of stainless steel AISI 430F. Standard limit switches are not cULus certified.

4

Rated revolution ratio	Real revolution ratio	No. of cams and switches	Switches	
			PRSL0110XX 1NO+1NC	PRSL0111XX 1NC
				
			Code	Code
1:15	1:16	2	PFB9067L0016010	PFB9067L0016012
		3	PFB9067L0016011	PFB9067L0016013
		4	PFB9067L0016008	PFB9067L0016014
1:20	1:20.21	2	PFB9067L0020006	PFB9067L0020008
		3	PFB9067L0020007	PFB9067L0020009
		4	PFB9067L0020004	PFB9067L0020010
1:25	1:27.27	2	PFB9067L0027007	PFB9067L0027017
		3	PFB9067L0027016	PFB9067L0027018
		4	PFB9067L0027014	PFB9067L0027019
1:50	1:62	2	PFB9067L0062033	PFB9067L0062045
		3	PFB9067L0062044	PFB9067L0062046
		4	PFB9067L0062003	PFB9067L0062025
1:75	1:75.48	2	PFB9067L0075008	PFB9067L0075010
		3	PFB9067L0075009	PFB9067L0075004
		4	PFB9067L0075006	PFB9067L0075011
1:100	1:103.44	2	PFB9067L0103037	PFB9067L0103038
		3	PFB9067L0103049	PFB9067L0103027
		4	PFB9067L0103030	PFB9067L0103050
1:150	1:162.52	2	PFB9067L0162007	PFB9067L0162008
		3	PFB9067L0162006	PFB9067L0162009
		4	PFB9067L0162003	PFB9067L0162002
1:200	1:222.58	2	PFB9067L0222011	PFB9067L0222014
		3	PFB9067L0222013	PFB9067L0222015
		4	PFB9067L0222010	PFB9067L0222016
1:250	1:254.57	2	PFB9067L0254019	PFB9067L0254010
		3	PFB9067L0254020	PFB9067L0254021
		4	PFB9067L0254008	PFB9067L0254022

ASSEMBLY DRAWING

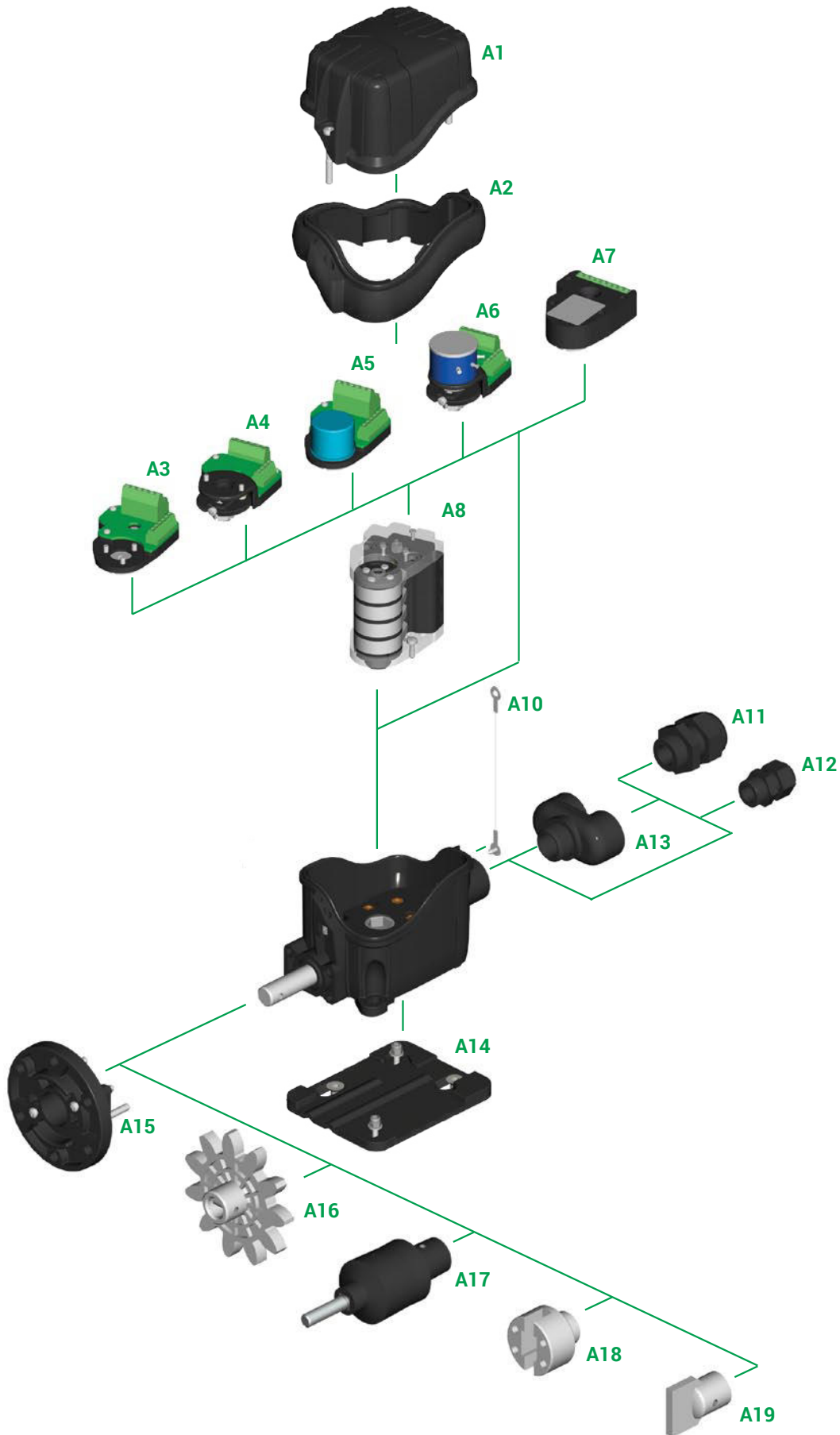



Refer to the following tables for descriptions of components: "Standard cam sets", "Potentiometers, encoders and sensors" and "Accessories".

COMPONENTS







Standard cam sets

4





Ref.	Drawing	No. and type of cams	No. and type of switches	Code	
		2 cams A	2 PRSL0110XX switches	FCL20001	
		2 cams A	2 PRSL0111XX switches	FCL20002	
		Cams A+C	2 PRSL0110XX switches	FCL20003	
		Cams A+C	2 PRSL0111XX switches	FCL20004	
		2 cams C	2 PRSL0110XX switches	FCL20005	
		2 cams C	2 PRSL0111XX switches	FCL20006	
	A8		Cams D+D+B+F	4 PRSL0110XX switches	FCL40001
			Cams D+D+B+F	4 PRSL0111XX switches	FCL40002
			4 cams A	4 PRSL0110XX switches	FCL40003
			4 cams A	4 PRSL0111XX switches	FCL40004
			Cams A+A+C+C	4 PRSL0110XX switches	FCL40005
			Cams A+A+C+C	4 PRSL0111XX switches	FCL40006
			4 cams C	4 PRSL0110XX switches	FCL40007
			4 cams C	4 PRSL0111XX switches	FCL40008
			Cams C+C+C+E	4 PRSL0110XX switches	FCL40009
			Cams C+C+C+E	4 PRSL0111XX switches	FCL40010
			Cams A+A+E+E	4 PRSL0110XX switches	FCL40011
			Cams A+A+E+E	4 PRSL0111XX switches	FCL40012

Other sets with 2/3/4 or 5 cams/switches are available on request.





Cam reference chart

Cam			Code for PRSL0110XX switches	Switching angle with PRSL0110XX	Code for PRSL0111XX switches	Switching angle with PRSL0111XX
A		1 point	PRSL7194PI	21.5° ±0.5°	PRSL7194PI	23.0° ±0.5°
B		10 points	PRSL7193PI	21.5° ±0.5°	PRSL7193PI	23.0° ±0.5°
C		60° sector	PRSL7195PI	82.0° ±0.5°	PRSL7195PI	86.0° ±0.5°
D		72° sector	PRSL7196PI	94.0° ±0.5°	PRSL7196PI	97.5° ±0.5°
E		180° sector	PRSL7191PI	204.5° ±0.5°	PRSL7191PI	203.0° ±0.5°
F		305° sector	PRSL7192PI	328.5° ±0.5°	PRSL7192PI	327.0° ±0.5°

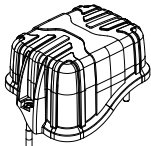
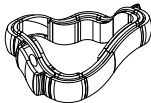

Potentiometers, encoders and sensors

Ref.	Drawing	Description	Code
A3		Support for encoder	PA030000
A4		Support for potentiometer	PA020000
A5		Encoder 36 pulses./rev. with support	PA030001
		Encoder 150 pulses./rev. with support	PA030002
A6		Potentiometer 10 kΩ with support	PA020001
		Potentiometer 10 kΩ mechanical stop with support	PA020002
		Potentiometer 10 kΩ ±10% 4 pins with support	PA020003
		Potentiometer 10 kΩ ±10% 3 pins with support	PA020004
		Potentiometer 5 kΩ ±10% with support	PA020005
A7		Absolute encoder Yankee - current output	PA01AA01
		Absolute encoder Yankee - voltage output	PA01AB01
		Absolute encoder Yankee - PWM output	PA01AC01

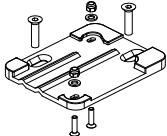
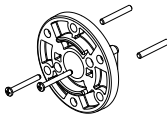
Accessories

Ref.	Drawing	Description	Code
A1		Cover with screws	PA090017
A2		Tightening rubber	PRGU1500PE
A10		Cover holding wire + screw (bag with 10 pieces)	PRSL0358PI
A11		Cable clamp M20	PRPS0064PE
A12		Cable clamp M16	PRPS0062PE
A13		Cable clamp holder with 2 outputs M20	PRSL9051PI
		Cable clamp holder with 2 outputs M20+M16	PRSL9052PI
A14		Fixing plate	PRSL0430PI
A15		Flange with screws and pins	PRSL0356PI

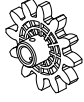
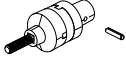
Accessories

Ref.	Drawing	Description	Code
A16		Pinion gear	See pinion gear tables
A17		Coupling with pin	PRSL0981PI
A18		Female coupling with pin	PRSL0920PI
A19		Male coupling with pin	PRSL0919PI

Moulded pinion gears

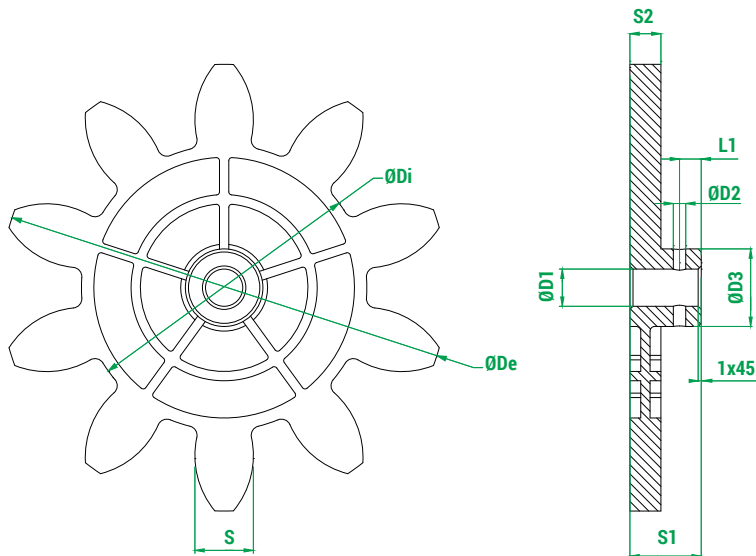

Legend

Z	Number of teeth
M	Module
Dp	Primitive diameter
De	External diameter
Di	Internal diameter
a	Addendum
d	Dedendum
Alpha	Pressure angle

Code	Z	M	Dp	De	Di	a	d	S	Alpha	D1	D2	D3	S1	S2	L1
PRSL0915PI	8	20.00	160.00	200.00	113.20	20.00	23.40	31.41	20.00	12.00	4.00	24.00	23.00	10.00	7.00
PRSL0912PI	10	12.00	120.00	144.00	92.00	12.00	14.00	18.85	20.00	12.00	4.00	25.00	23.00	10.00	7.00
PRSL0913PI	10	14.00	140.00	168.00	107.24	14.00	16.38	21.99	20.00	12.00	4.00	24.60	23.00	10.00	7.00
PRSL0914PI	10	16.00	160.00	192.00	122.67	16.00	18.67	25.13	20.00	12.00	4.00	24.00	23.00	10.00	7.00
PRSL0917PI	11	6.00	66.00	78.00	51.96	6.00	7.02	9.42	20.00	12.00	4.00	19.00	23.00	8.00	7.00
PRSL0916PI	12	5.00	60.00	70.00	48.30	5.00	5.83	7.85	20.00	12.00	4.00	20.00	23.00	8.00	7.00
PRSL0918PI	12	8.00	96.00	112.00	77.28	8.00	9.36	12.56	20.00	12.00	4.00	21.50	23.50	10.00	7.00
PRSL0911PI	12	10.00	120.00	140.00	96.67	10.00	11.67	15.71	20.00	12.00	4.00	25.00	23.50	10.00	7.00
PRSL0944PI	12	12.00	144.00	168.00	116.00	12.00	14.00	18.85	20.00	12.00	4.00	24.00	23.00	10.00	7.00

Measuring unit: mm.

Waterjet cut pinion gears

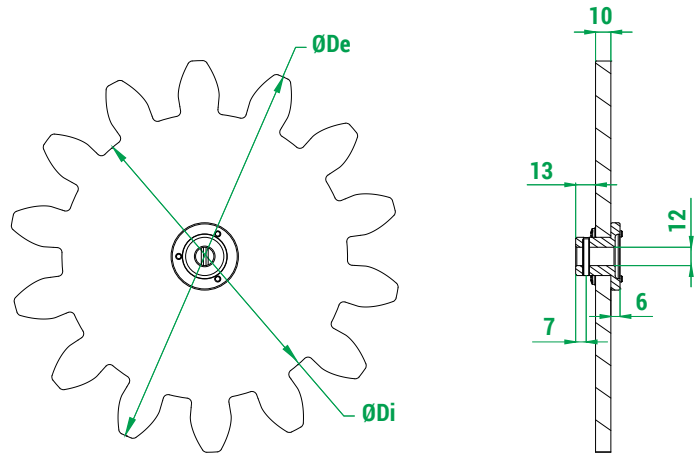

Legend	
Z	Number of teeth
M	Module
Dp	Primitive diameter
De	External diameter
Di	Internal diameter
a	Addendum
d	Dedendum
Alpha	Pressure angle

Code	Z	M	Dp	De	Di	a	d	Alpha
PRSL0857PI	8	18.00	144.00	180.00	102.00	18.00	21.00	20.00
PRSL0855PI	8	24.00	192.00	240.00	136.00	24.00	28.00	20.00
PRSL0992PI	9	10.00	90.00	110.00	66.67	10.00	11.67	20.00
PRSL0879PI	9	16.00	144.00	176.00	106.67	16.00	18.67	20.00
PRSL0854PI	9	18.00	162.00	198.00	120.00	18.00	21.00	20.00
PRSL0871PI	9	20.00	180.00	220.00	133.33	20.00	23.33	20.00
PRSL0849PI	9	24.00	216.00	264.00	160.00	24.00	28.00	20.00
PRSL0846PI	10	10.00	100.00	120.00	76.67	10.00	11.67	20.00
PRSL0993PI	10	18.00	180.00	216.00	138.00	18.00	21.00	20.00
PRSL0970PI	10	22.00	220.00	264.00	168.52	22.00	25.74	20.00
PRSL0856PI	10	24.00	240.00	288.00	184.00	24.00	28.00	20.00
PRSL0861PI	11	12.00	132.00	156.00	104.00	12.00	14.00	20.00
PRSL0998PI	11	18.00	198.00	234.00	156.00	18.00	21.00	20.00
PRSL0997PI	11	20.00	220.00	260.00	173.36	20.00	23.32	20.00
PRSL0859PI	11	24.00	264.00	312.00	204.00	24.00	30.00	20.00
PRSL0863PI	12	14.00	168.00	196.00	133.00	14.00	17.50	20.00
PRSL0897PI	12	16.00	192.00	224.00	154.67	16.00	18.67	20.00
PRSL0972PI	12	18.00	216.00	252.00	173.88	18.00	21.06	20.00
PRSL0845PI	12	20.00	240.00	280.00	193.34	20.00	23.32	20.00
PRSL0878PI	12	24.00	288.00	336.00	232.00	24.00	28.00	20.00
PRSL0860PI	13	6.00	78.00	90.00	63.00	6.00	7.50	20.00
PRSL0853PI	13	12.00	156.00	178.59	126.00	11.29	15.00	20.00
PRSL0898PI	13	16.00	208.00	240.00	170.67	16.00	18.66	20.00
PRSL0862PI	14	10.00	140.00	169.00	125.00	15.00	7.50	20.00
PRSL0896PI	14	16.00	224.00	256.00	186.67	16.00	18.67	20.00
PRSL0999PI	14	18.00	252.00	288.00	210.00	18.00	21.00	20.00
PRSL0848PI	14	20.00	280.00	320.00	233.33	20.00	23.33	20.00
PRSL0858PI	15	18.00	270.00	306.00	228.00	18.00	21.00	20.00
PRSL0847PI	16	20.00	320.00	360.00	273.33	20.00	23.33	20.00
PRSL0973PI	17	10.00	170.00	190.00	145.00	10.00	12.50	22.89
PRSL0974PI	17	14.00	238.00	266.00	203.00	14.00	17.50	22.89
PRSL0851PI	20	6.00	120.00	132.00	105.00	6.00	7.50	22.89
PRSL0844PI	25	1.00	25.00	27.00	22.50	1.00	1.25	22.89

Measuring unit: mm.

FOX - REQUEST FORM FOR NON STANDARD LIMIT SWITCH

4

Instructions

(See next page for list of components and legends)

- 1 Version:** tick the required version.
- 2 SIL 1 certified:** tick the box if you require SIL 1 certified units.
- 3 Revolution ratio:** write the required revolution ratio.
- 4 Standard cam set:** write the code of the cam set required.
- 5 Customized cam set:** for non standard cam sets, fill in the scheme choosing the cams and the switches required. It is possible to assemble sets with 2, 3, 4 or 5 cams/switches.
Customized cams are available on request.
- 6 Potentiometer. encoder. Yankee:** write the code of the potentiometer, encoder or Yankee required.
ATTENTION: it is possible to mount a potentiometer or an encoder alone or together with a set of 2 or 3 cams/switches. Potentiometers PA020001 and PA020002 can be mounted only with sets of 2 cams/switches.
ATTENTION: Yankee may be mouted alone or together with a set of max. 4 cams/switches.
- 7 Cable clamp:** tick the cable clamp required.
- 8 Coupling, flange, pinion gear:** tick the box when coupling, flange or pinion gear are required.
When a standard pinion gear is required, write the code number listed in the pinion gear tables in the catalogue.
When a special pinion gear is required, write the number of teeth, the module and the primitive diameter.
- 9 Shaft:** tick the shaft type required.
Customized shafts are available on request.
- 10 Cover holding wire:** tick when the cover holding wire is required.

Version **1**

- Version **CE EAC**
- Version **cULus CE EAC**
- Version with anti-moisture plug **CE EAC**

ATTENTION: Limit switches with shafts made of stainless steel AISI 430F are not cULus certified.

SIL1 certified **2**

Revolution ratio **3**

- | | |
|--------------------------------|---|
| <input type="checkbox"/> 1:15 | <input type="checkbox"/> 1:150 |
| <input type="checkbox"/> 1:20 | <input type="checkbox"/> 1:200 |
| <input type="checkbox"/> 1:25 | <input type="checkbox"/> 1:250 |
| <input type="checkbox"/> 1:50 | <input type="checkbox"/> 1:300 |
| <input type="checkbox"/> 1:75 | <input type="checkbox"/> 1:450 |
| <input type="checkbox"/> 1:100 | <input type="checkbox"/> 1: <input style="width: 50px;" type="text"/> |

Standard cam set **4**

Cam set code _____

Customized cam set **5**

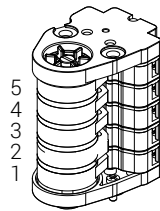

Cam code	Switch code
5 _____	_____
4 _____	_____
3 _____	_____
2 _____	_____
1 _____	_____

Potentiometer. encoder. Yankee **6**

Code _____

Cable clamp **7**

- M20 M20+M16
- M20+M20

Male coupling Coupling **8**

Female coupling Flange

Pinion gear

Pinion gear code _____

Customized pinion gear

No. of teeth _____

Module _____

Primitive diameter _____

Standard shaft **9**

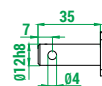

- Stainless steel AISI 430F shaft
- High resistance stainless steel AISI 303 shaft

Flexible shaft

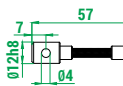

- Stainless steel AISI 430F shaft
- High resistance stainless steel AISI 303 shaft

Cover holding wire **10**

4 Legend - Standard cam sets

No. & type of switches	No. & type of cams	Code
2 x PRSL0110XX	2 cams A	FCL20001
	Cams A+C	FCL20003
4 x PRSL0110XX	2 cams C	FCL20005
	Cams D+D+B+F	FCL40001
	4 cams A	FCL40003
	Cams A+A+C+C	FCL40005
	4 cams C	FCL40007
	Cams C+C+C+E	FCL40009
2 x PRSL0111XX	Cams A+A+E+E	FCL40011
	2 cams A	FCL20002
	Cams A+C	FCL20004
4 x PRSL0111XX	2 cams C	FCL20006
	Cams D+D+B+F	FCL40002
	4 cams A	FCL40004
	Cams A+A+C+C	FCL40006
	4 cams C	FCL40008
	Cams C+C+C+E	FCL40010
	Cams A+A+E+E	FCL40012

6 Legend - Potentiometers, encoders and Yankee

Description	Code
Potentiometer 10 kΩ with support	PA020001
Potentiometer 10 kΩ mechanical stop with support	PA020002
Potentiometer 10 kΩ ±10% 4 pins with support	PA020003
Potentiometer 10 kΩ ±10% 3 pins with support	PA020004
Potentiometer 5 kΩ ±10% with support	PA020005
Encoder 36 pulses./rev. with support	PA030001
Encoder 150 pulses./rev. with support	PA030002
Yankee - current output	PA01AA01
Yankee - voltage output	PA01AB01
Yankee - PWM output	PA01AC01

5 Legend - Switches

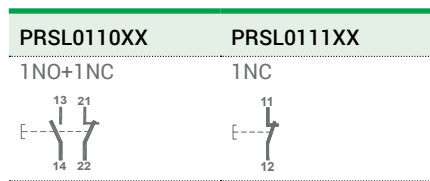

5 Legend - Standard cams

Cam	Code for PRSL0110XX switches	Switching angle with PRSL0110XX	Code for PRSL0111XX switches	Switching angle with PRSL0111XX	
A	1 point	PRSL7194PI	21.5° ±0.5°	PRSL7194PI	23.0° ±0.5°
B	10 points	PRSL7193PI	21.5° ±0.5°	PRSL7193PI	23.0° ±0.5°
C	60° sector	PRSL7195PI	82.0° ±0.5°	PRSL7195PI	86.0° ±0.5°
D	72° sector	PRSL7196PI	94.0° ±0.5°	PRSL7196PI	97.5° ±0.5°
E	180° sector	PRSL7191PI	204.5° ±0.5°	PRSL7191PI	203.0° ±0.5°
F	305° sector	PRSL7192PI	328.5° ±0.5°	PRSL7192PI	327.0° ±0.5°

